

KBS 60W NB

Linear bushing

TYPE: Shaft guidance systems, Linear bushing, Standard, Close type, double length, Type KB..W, European standard, Corrosion resistance, Stainless steel cage (NB)

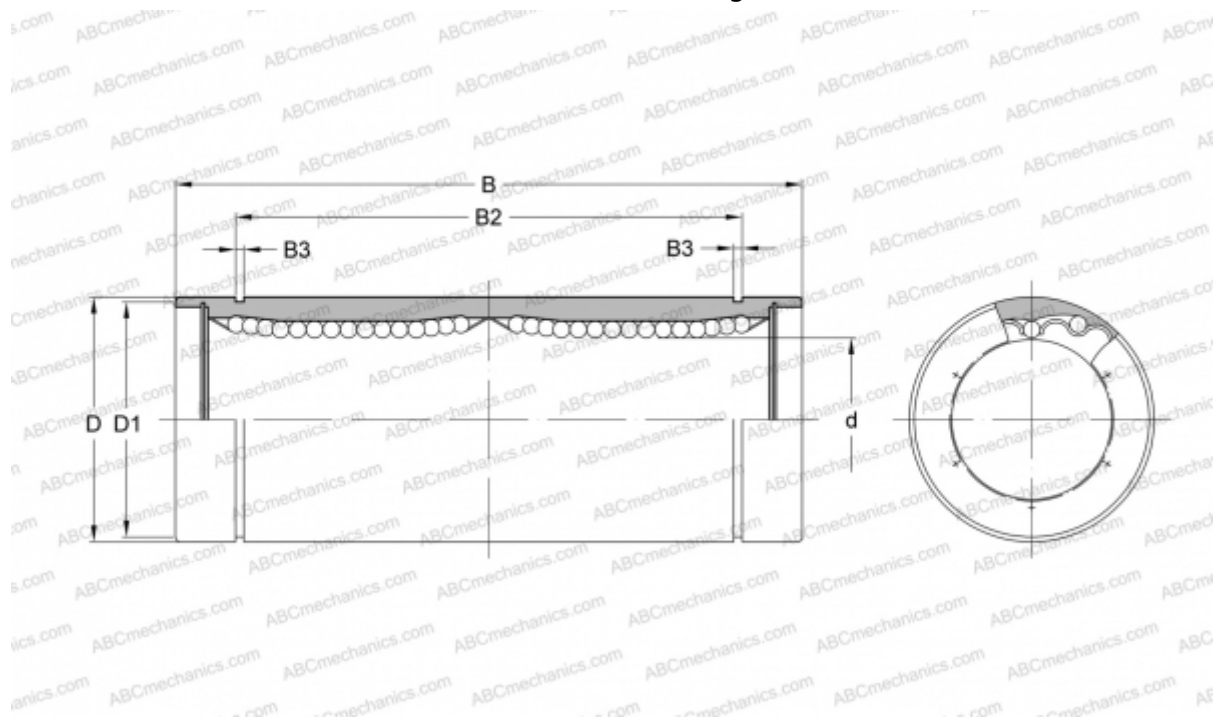

Technical specification

DIMENSIONS, MM

d	60,000
D	90,000
B	209,000
D1	86,500
B2	170,000
B3	3,150

WEIGHT, KG 3,920

MANUFACTURER [NB](#)