

KBS 8GW NB

Linear bushing

TYPE: Shaft guidance systems, Linear bushing, Standard, Close type, double length, Type KB..W, European standard, Corrosion resistance, Plastic cage (NB)

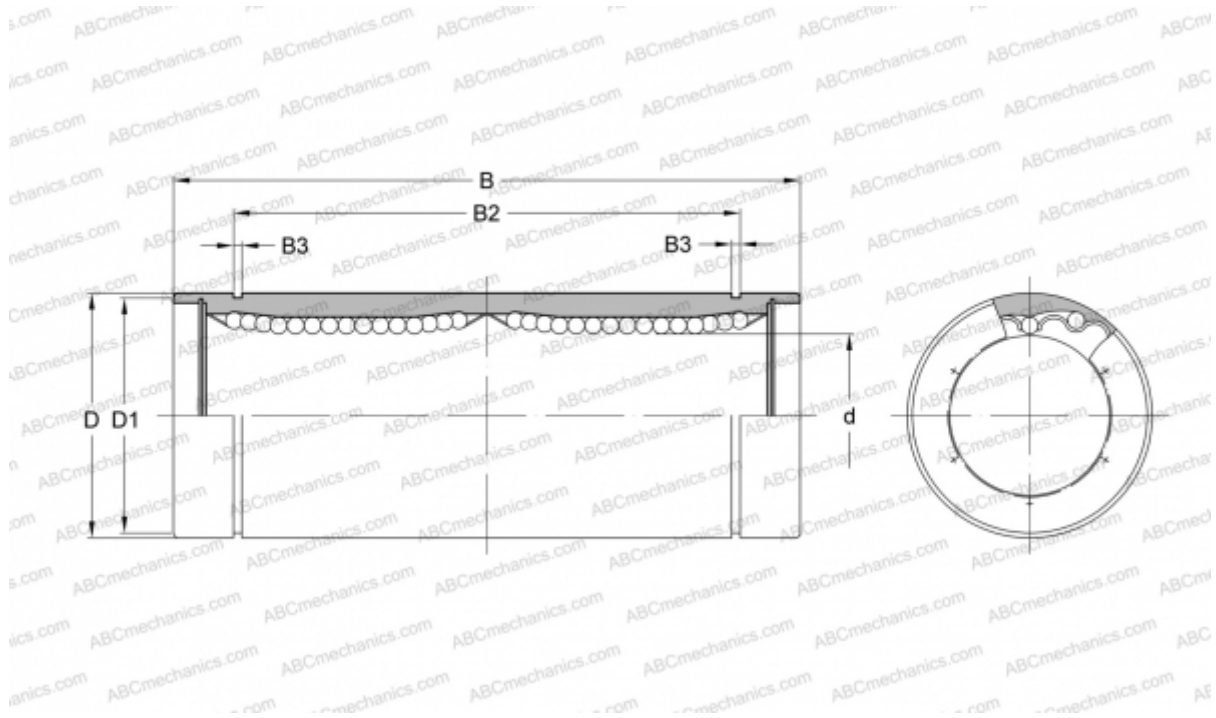

Technical specification

DIMENSIONS, MM

d	8,000
D	16,000
B	46,000
D1	15,200
B2	33,000
B3	1,100

WEIGHT, KG 0,040

MANUFACTURER [NB](#)