

## KBS 40GW NB

Linear bushing

TYPE: Shaft guidance systems, Linear bushing, Standard, Close type, double length, Type KB..W, European standard, Corrosion resistance, Plastic cage (NB)

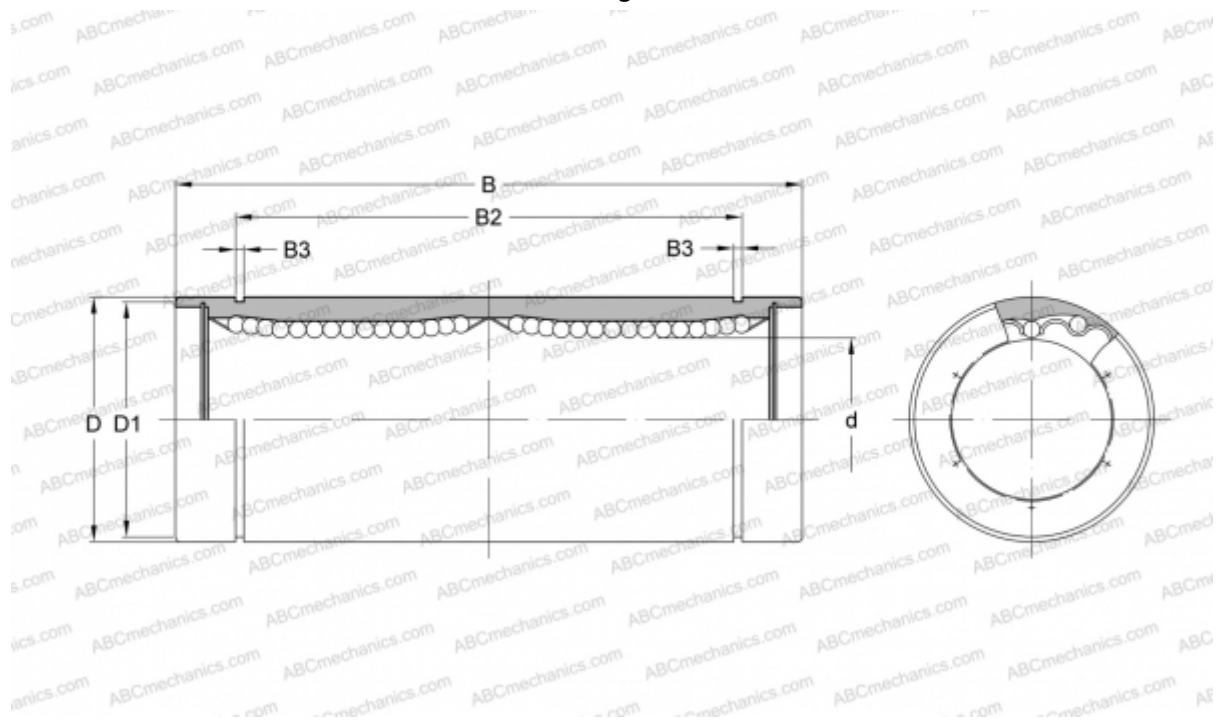

### Technical specification

#### DIMENSIONS, MM

d	40,000
D	62,000
B	151,000
D1	59,000
B2	121,200
B3	2,150

**WEIGHT, KG** 1,400

**MANUFACTURER** [NB](#)