

KBF 40 NB

Linear bushing

TYPE: Shaft guidance systems, Linear bushing, With flange, Circular type, Type KBF, European standard, Steel cage (NB)

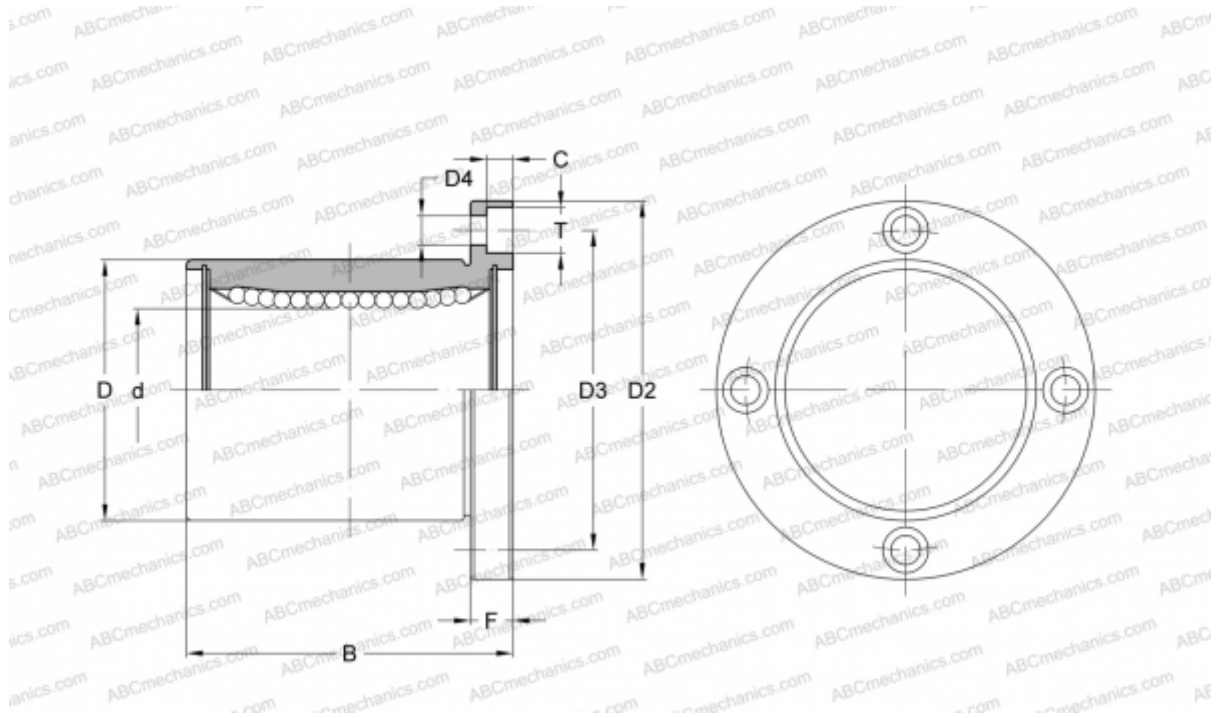

Technical specification

DIMENSIONS, MM

d	40,000
D	62,000
B	80,000
D2	98,000
D3	80,000
F	13

WEIGHT, KG 1,175

MANUFACTURER [NB](#)