

KBF 5G NB

Linear bushing

TYPE: Shaft guidance systems, Linear bushing, With flange, Circular type, Type KBF, European standard, Plastic cage (NB)

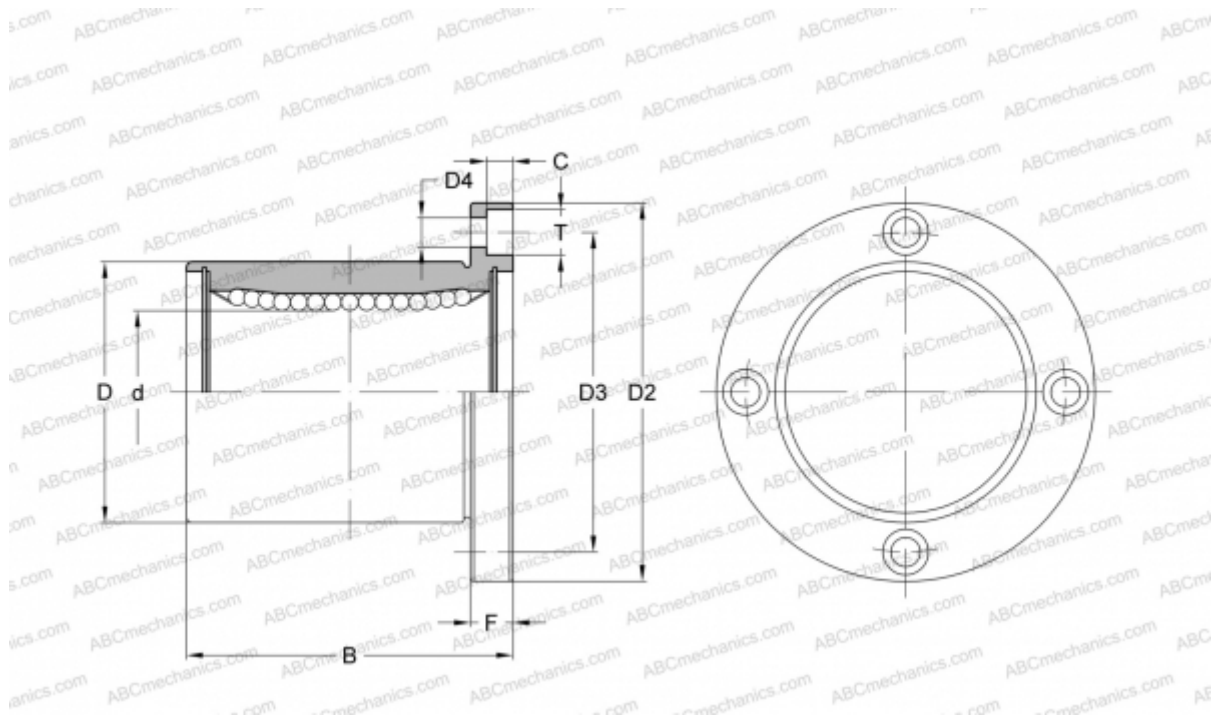

Technical specification

DIMENSIONS, MM

d	5,000
D	12,000
B	22,000
D2	28,000
D3	20,000
F	5

WEIGHT, KG 0,026

MANUFACTURER [NB](#)