

KBF 12G NB

Linear bushing

TYPE: Shaft guidance systems, Linear bushing, With flange, Circular type, Type KBF, European standard, Plastic cage (NB)

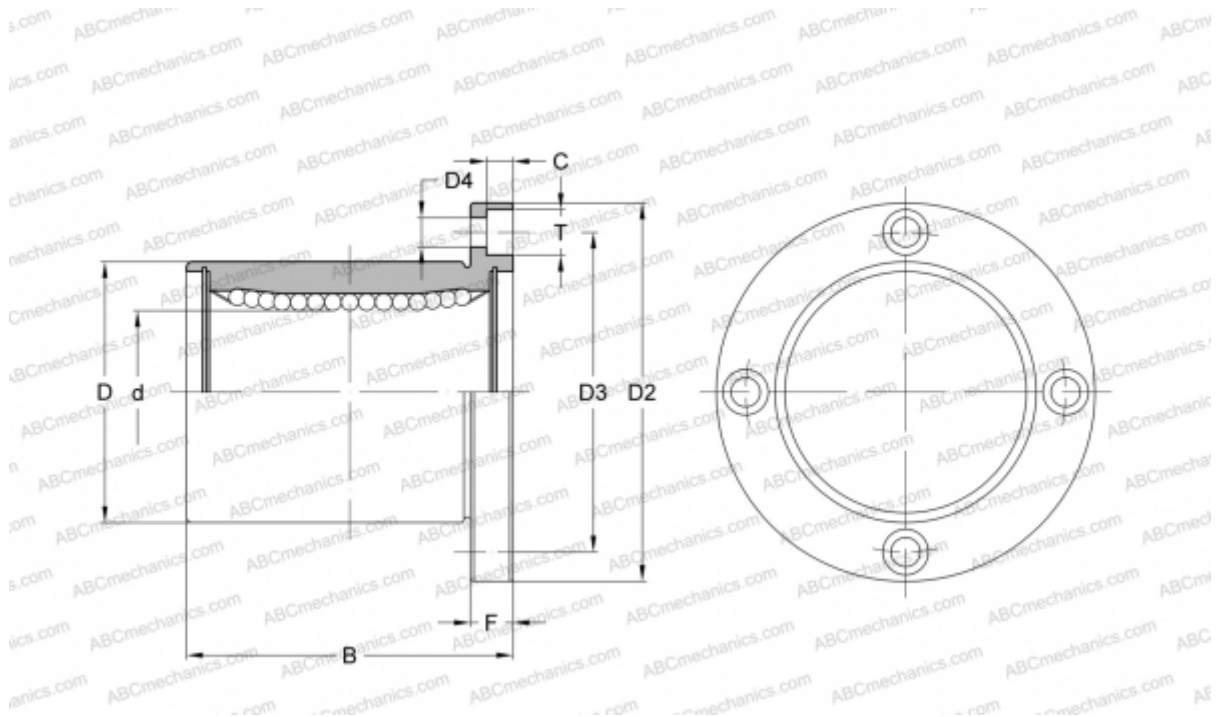

Technical specification

DIMENSIONS, MM

d	12,000
D	22,000
B	32,000
D2	42,000
D3	32,000
F	6

WEIGHT, KG 0,080

MANUFACTURER [NB](#)