

KBF 16G NB

Linear bushing

TYPE: Shaft guidance systems, Linear bushing, With flange, Circular type, Type KBF, European standard, Plastic cage (NB)

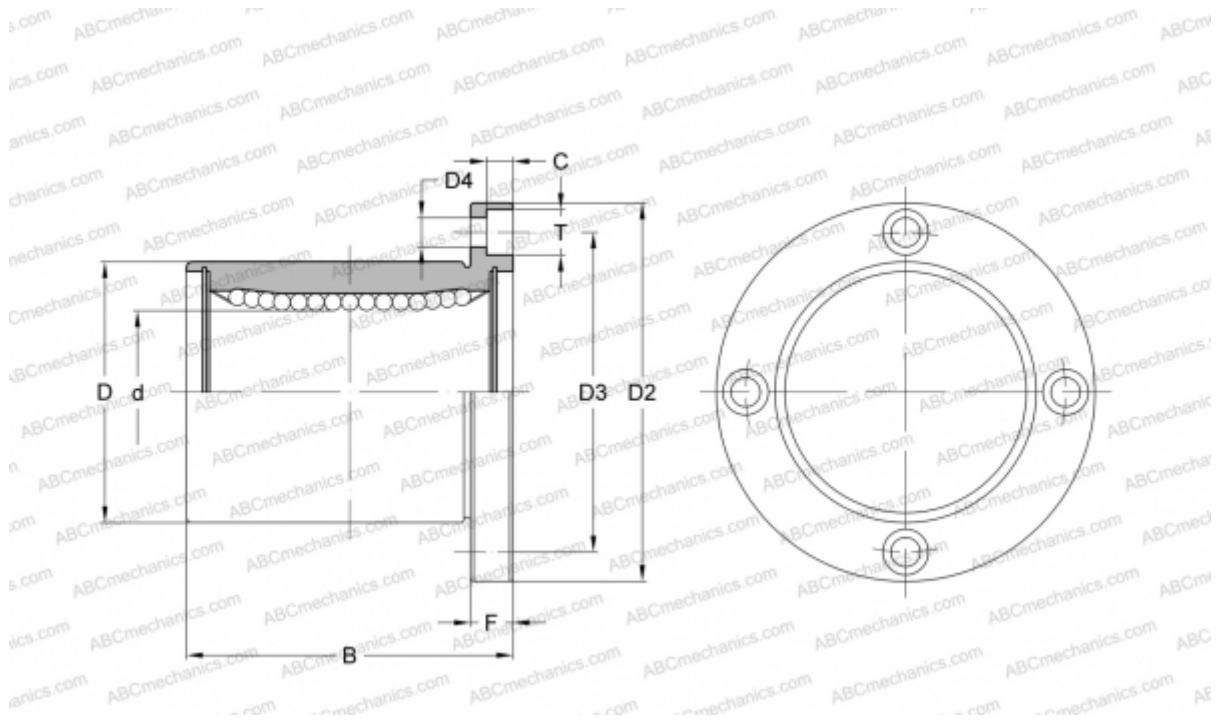

Technical specification

DIMENSIONS, MM

d	16,000
D	26,000
B	36,000
D2	46,000
D3	36,000
F	6

WEIGHT, KG 0,103

MANUFACTURER [NB](#)