

KBF 20G NB

Linear bushing

TYPE: Shaft guidance systems, Linear bushing, With flange, Circular type, Type KBF, European standard, Plastic cage (NB)

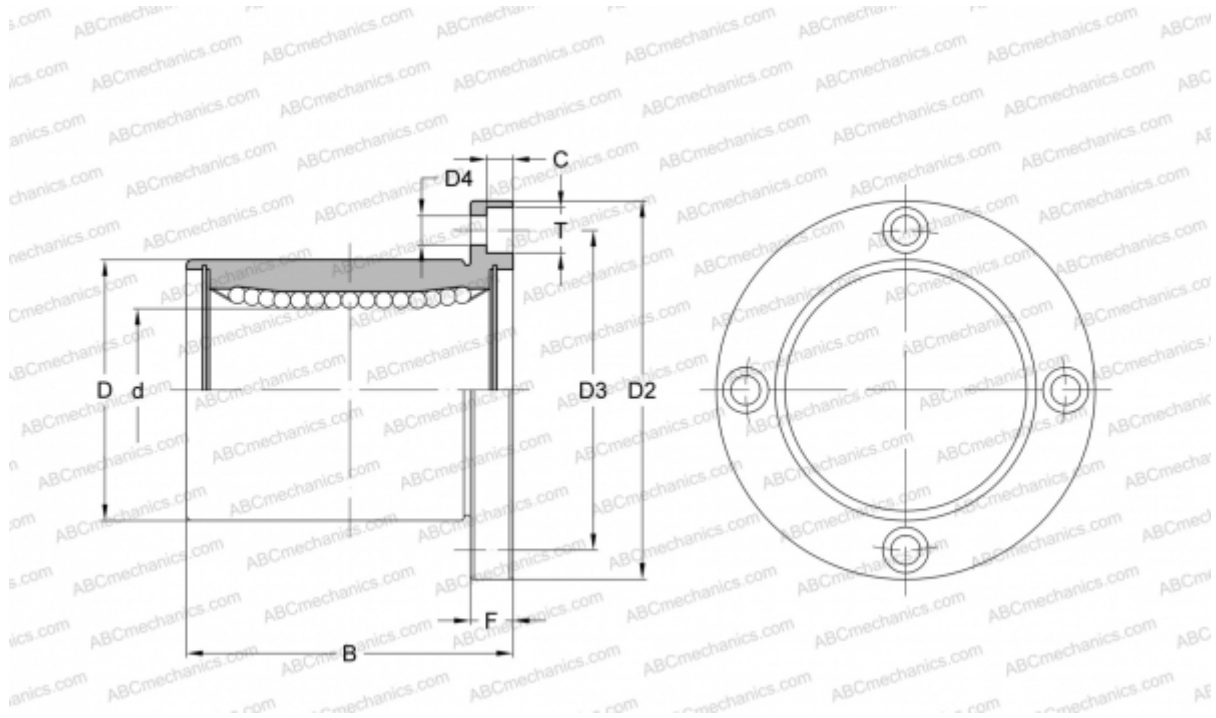

Technical specification

DIMENSIONS, MM

d	20,000
D	32,000
B	45,000
D2	54,000
D3	43,000
F	8

WEIGHT, KG 0,182

MANUFACTURER [NB](#)