

## KBF 25G NB

Linear bushing

TYPE: Shaft guidance systems, Linear bushing, With flange, Circular type, Type KBF, European standard, Plastic cage (NB)

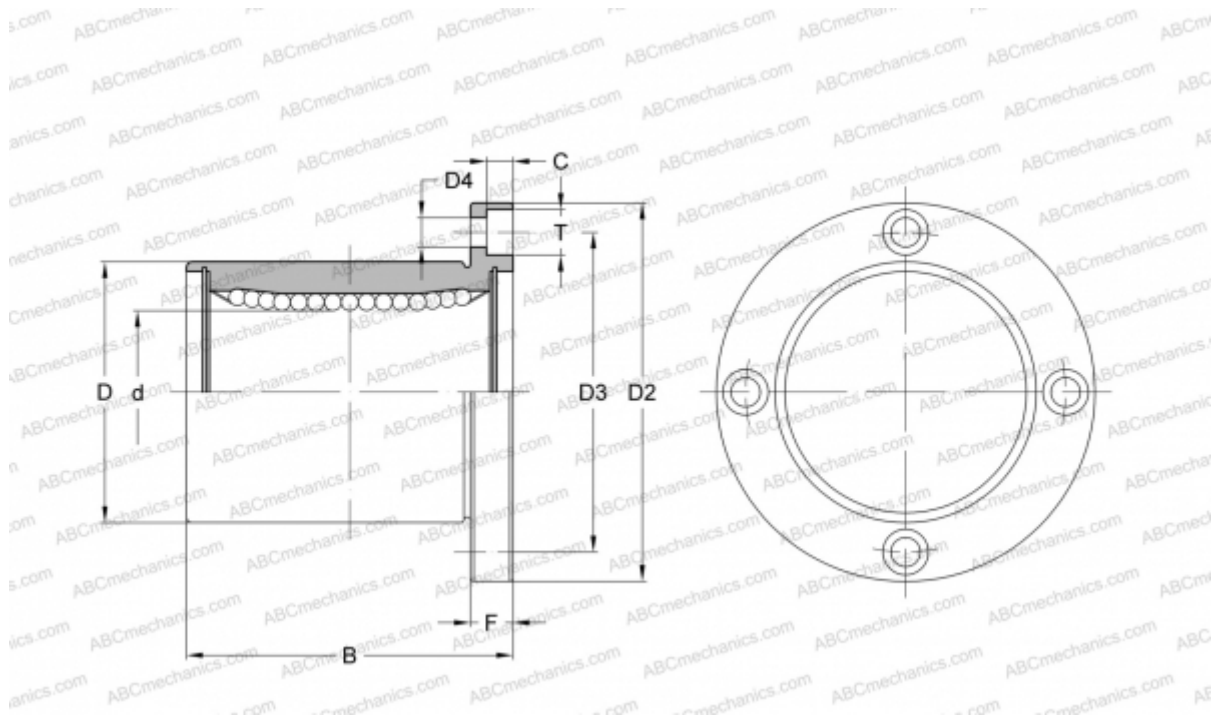

### Technical specification

#### DIMENSIONS, MM

d	25,000
D	40,000
B	58,000
D2	62,000
D3	51,000
F	8

**WEIGHT, KG** 0,335

**MANUFACTURER** [NB](#)