

KBSF 30 NB

Linear bushing

TYPE: Shaft guidance systems, Linear bushing, With flange, Circular type, Type KBF, European standard, Corrosion resistance, Stainless steel cage (NB)

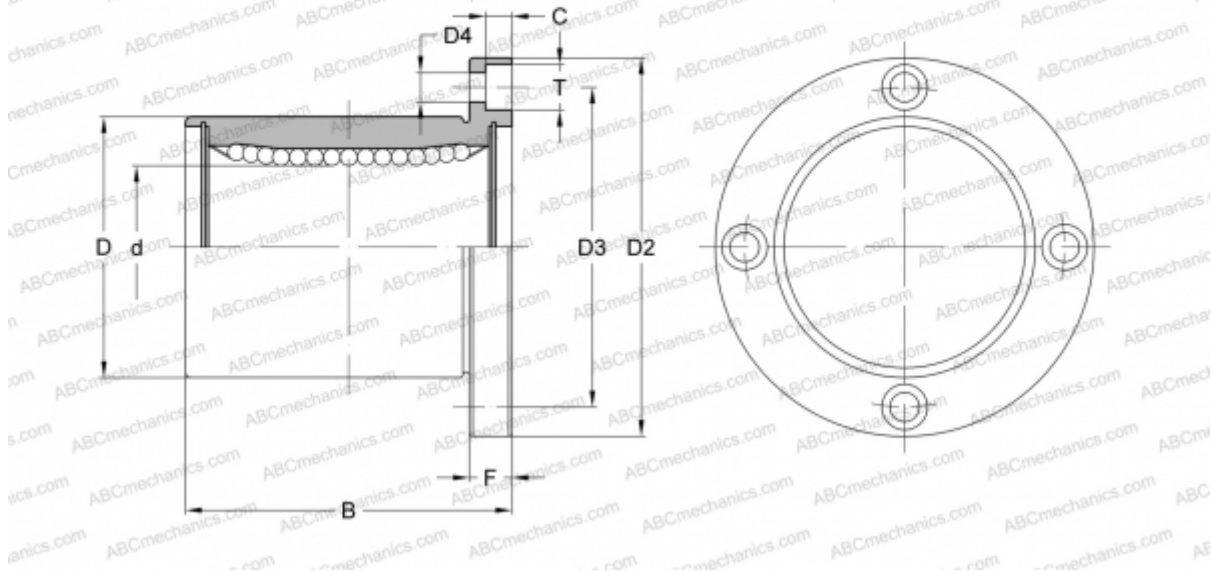

Technical specification

DIMENSIONS, MM

d	30,000
D	47,000
B	68,000
D2	76,000
D3	62,000
F	10

WEIGHT, KG 0,560

MANUFACTURER [NB](#)