

KBSF 50 NB

Linear bushing

TYPE: Shaft guidance systems, Linear bushing, With flange, Circular type, Type KBF, European standard, Corrosion resistance, Stainless steel cage (NB)

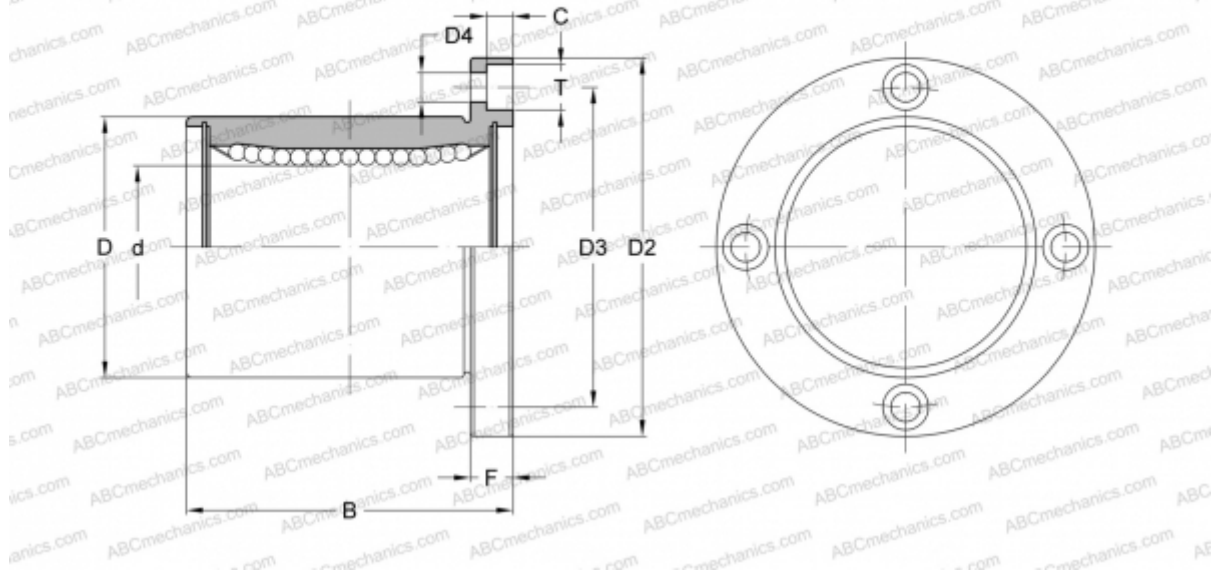

Technical specification

DIMENSIONS, MM

d	50,000
D	75,000
B	100,000
D2	112,000
D3	94,000
F	13

WEIGHT, KG 1,745

MANUFACTURER [NB](#)