

KBSF 8G NB

Linear bushing

TYPE: Shaft guidance systems, Linear bushing, With flange, Circular type, Type KBF, European standard, Corrosion resistance, Plastic cage (NB)

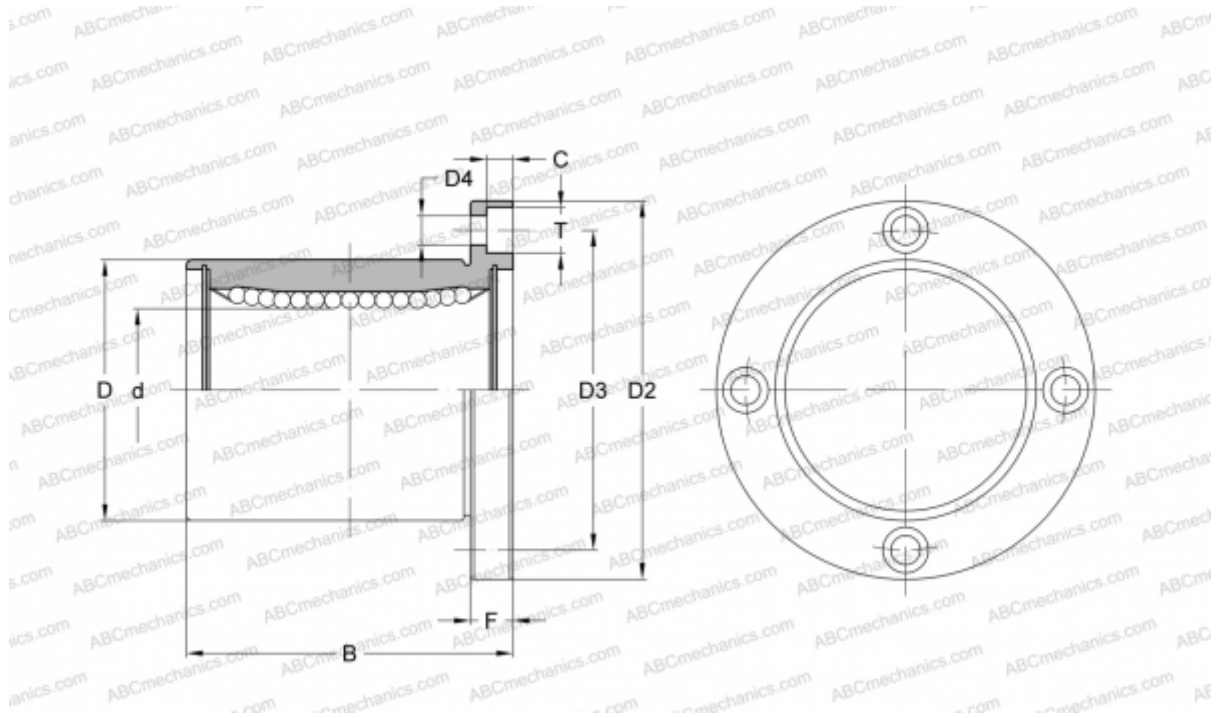

Technical specification

DIMENSIONS, MM

d	8,000
D	16,000
B	25,000
D2	32,000
D3	24,000
F	5

WEIGHT, KG 0,041

MANUFACTURER [NB](#)