

## KBSF 30G NB

Linear bushing

TYPE: Shaft guidance systems, Linear bushing, With flange, Circular type, Type KBF, European standard, Corrosion resistance, Plastic cage (NB)

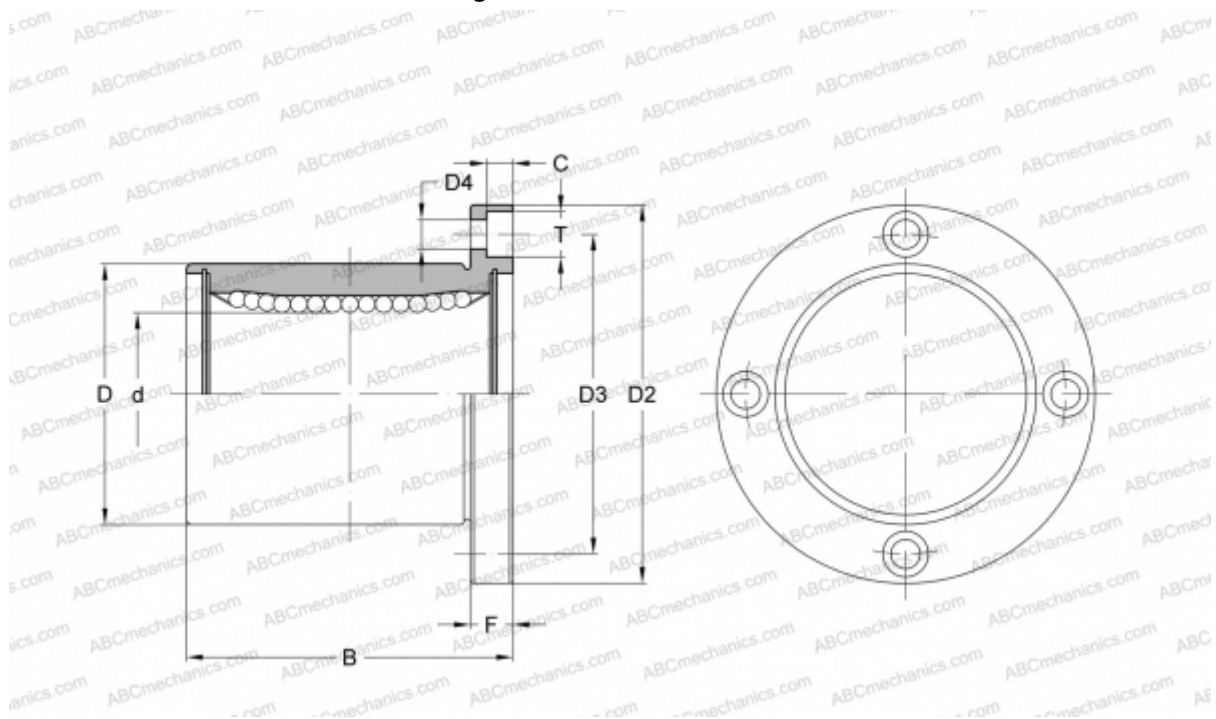

### Technical specification

#### DIMENSIONS, MM

d	30,000
D	47,000
B	68,000
D2	76,000
D3	62,000
F	10

**WEIGHT, KG** 0,560

**MANUFACTURER** [NB](#)