

## KBSF 50G NB

Linear bushing

TYPE: Shaft guidance systems, Linear bushing, With flange, Circular type, Type KBF, European standard, Corrosion resistance, Plastic cage (NB)

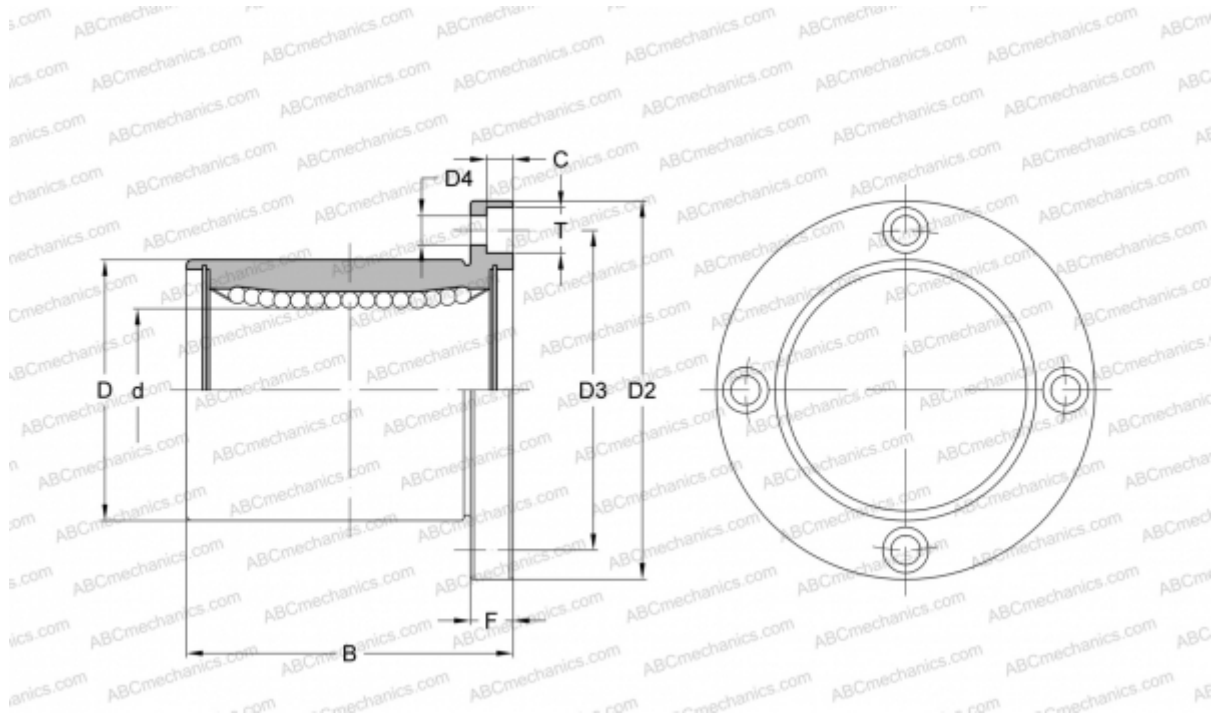

### Technical specification

#### DIMENSIONS, MM

d	50,000
D	75,000
B	100,000
D2	112,000
D3	94,000
F	13

**WEIGHT, KG** 1,745

**MANUFACTURER** [NB](#)