

## KBK 8 NB

Linear bushing

TYPE: Shaft guidance systems, Linear bushing, With flange, Square type, Type KBK, European standard, Steel cage (NB)

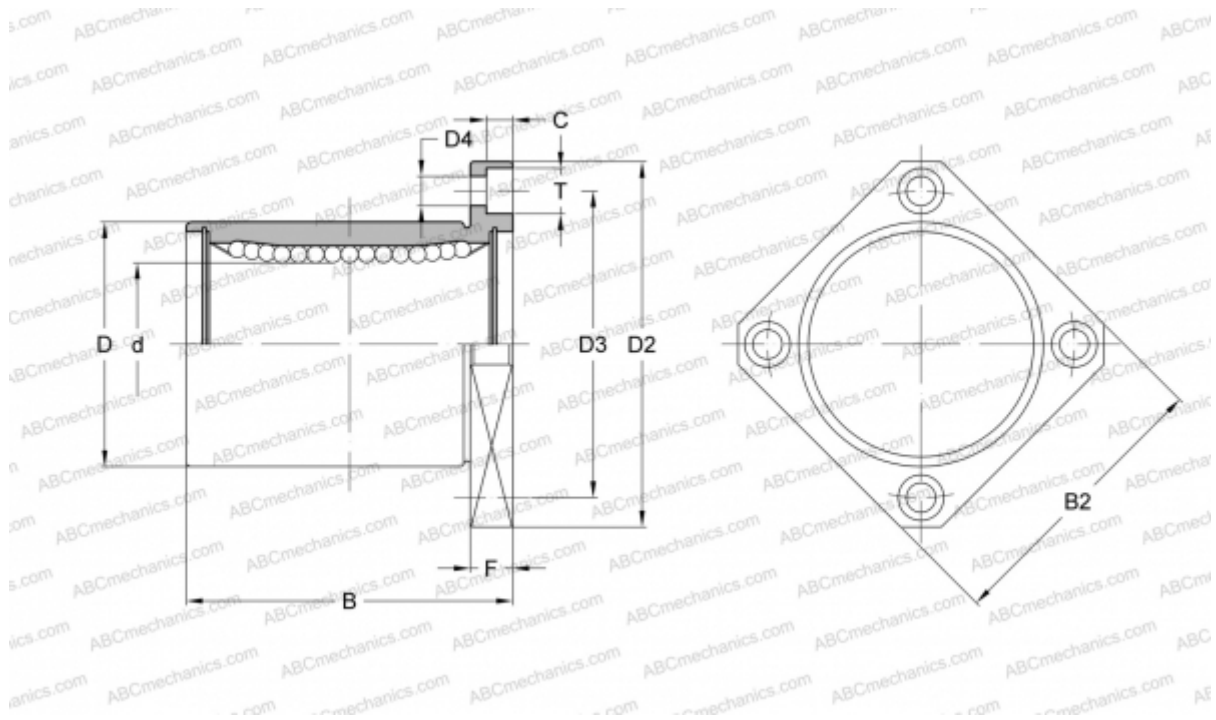

### Technical specification

#### DIMENSIONS, MM

d	8,000
D	16,000
B	25,000
D2	32,000
D3	24,000
D4	3,500
B2	25,000
T	6,000
C	3,100
F	5

**WEIGHT, KG** 0,033

**MANUFACTURER** [NB](#)