

## KBK 50 NB

Linear bushing

TYPE: Shaft guidance systems, Linear bushing, With flange, Square type, Type KBK, European standard, Steel cage (NB)

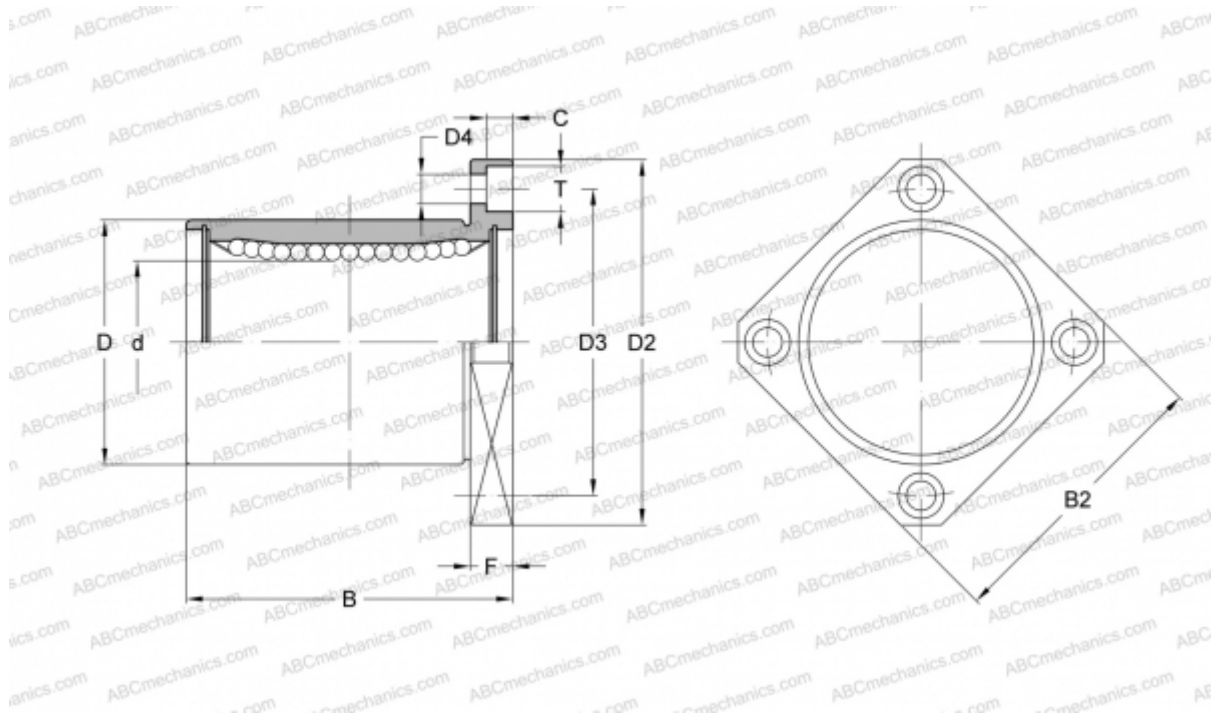

### Technical specification

#### DIMENSIONS, MM

d	50,000
D	75,000
B	100,000
D2	112,000
D3	94,000
D4	9,000
B2	88,000
T	14,000
C	8,100
F	13

**WEIGHT, KG** 1,545

**MANUFACTURER** [NB](#)