

KBK 5G NB

Linear bushing

TYPE: Shaft guidance systems, Linear bushing, With flange, Square type, Type KBK, European standard, Plastic cage (NB)

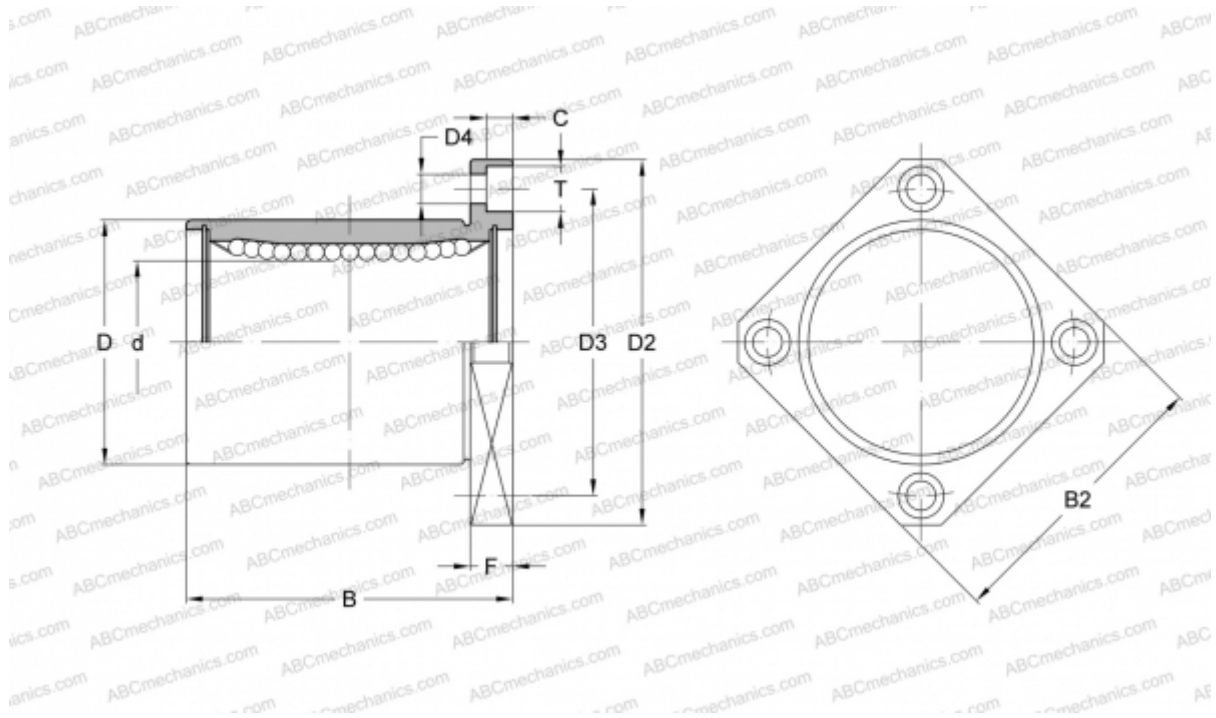

Technical specification

DIMENSIONS, MM

d	5,000
D	12,000
B	22,000
D2	28,000
D3	20,000
D4	3,500
B2	22,000
T	6,000
C	3,100
F	5

WEIGHT, KG 0,020

MANUFACTURER [NB](#)