

KBK 12G NB

Linear bushing

TYPE: Shaft guidance systems, Linear bushing, With flange, Square type, Type KBK, European standard, Plastic cage (NB)

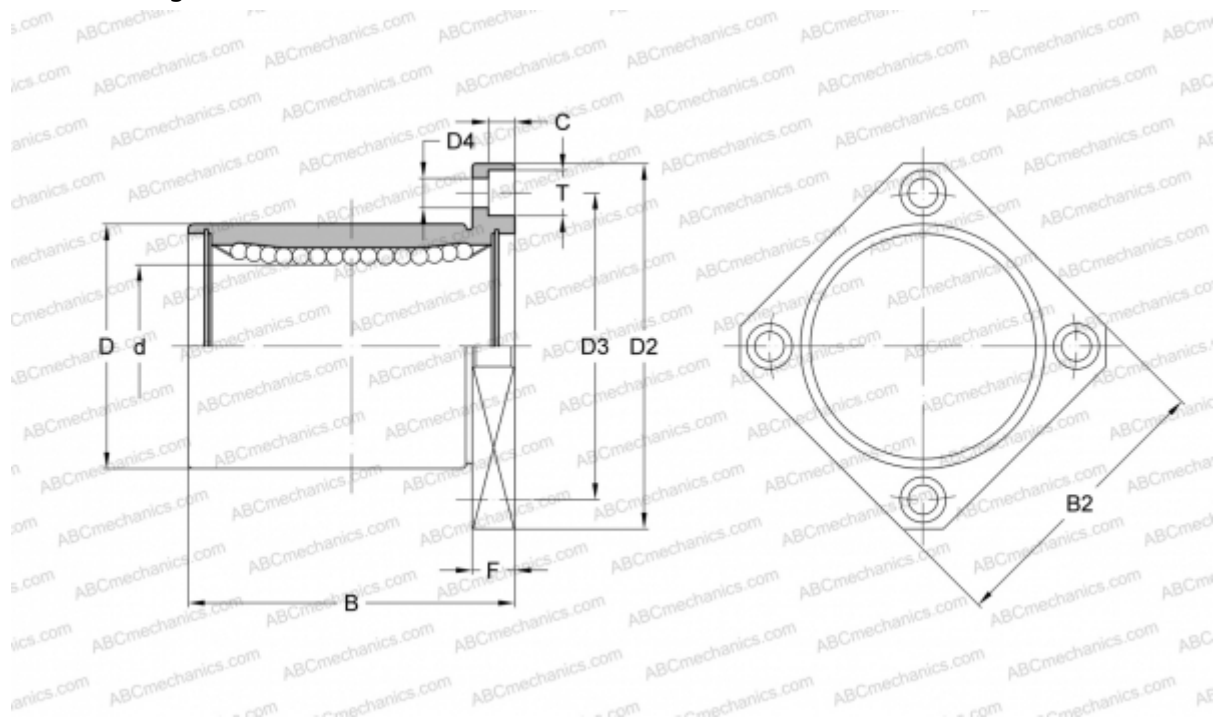

Technical specification

DIMENSIONS, MM

d	12,000
D	22,000
B	32,000
D2	42,000
D3	32,000
D4	4,500
B2	32,000
T	7,500
C	4,100
F	6

WEIGHT, KG 0,064

MANUFACTURER [NB](#)