

KBSF 40GW NB

Linear bushing

TYPE: Shaft guidance systems, Linear bushing, With flange, Circular type, double length, Type KBF..W, European standard, Corrosion resistance, Plastic cage (NB)

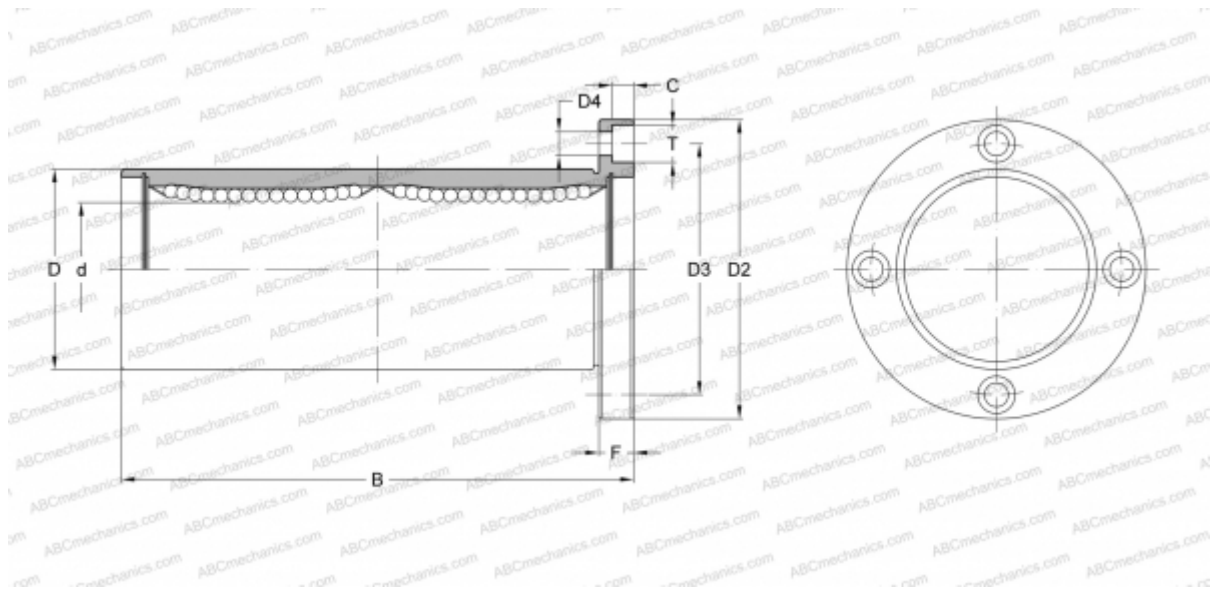

Technical specification

DIMENSIONS, MM

d	40,000
D	62,000
B	151,000
D2	98,000
D3	80,000
D4	9,000
T	14,000
C	8,100
F	13

WEIGHT, KG 1,805

MANUFACTURER [NB](#)