

KBK 12W NB

Linear bushing

TYPE: Shaft guidance systems, Linear bushing, With flange, Square type, double length, Type KBK..W, European standard, Steel cage (NB)

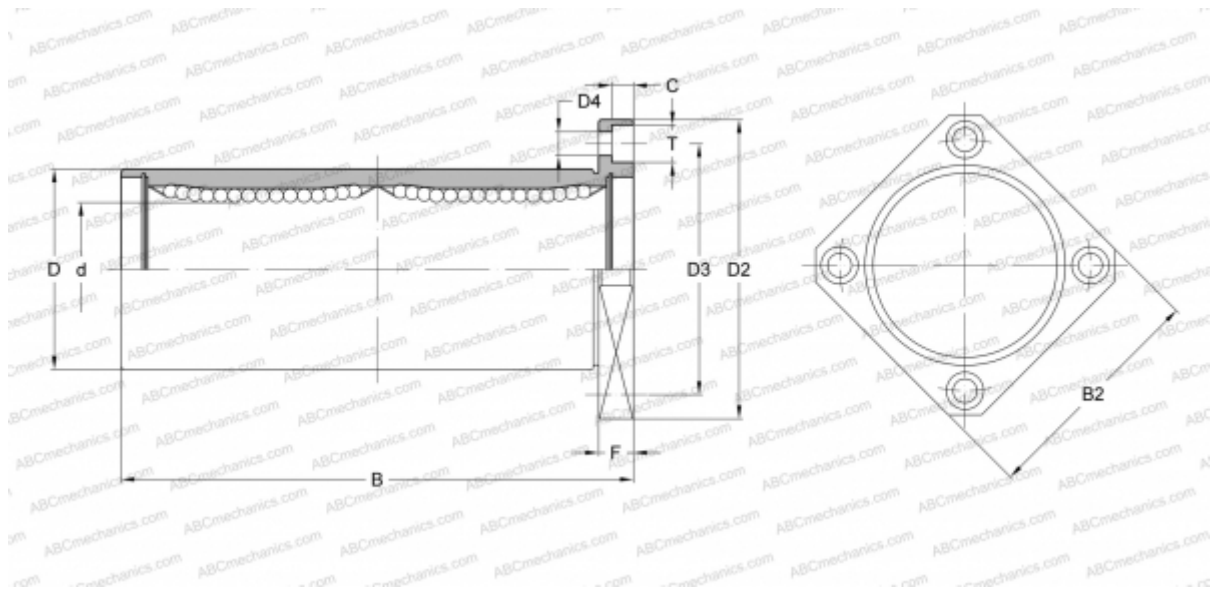

Technical specification

DIMENSIONS, MM

d	12,000
D	22,000
B	61,000
D2	42,000
D3	32,000
D4	4,500
B2	32,000
T	7,500
C	4,100
F	6

WEIGHT, KG 0,090

MANUFACTURER [NB](#)