

KBK 30GW NB

Linear bushing

TYPE: Shaft guidance systems, Linear bushing, With flange, Square type, double length, Type KBK..W, European standard, Plastic cage (NB)

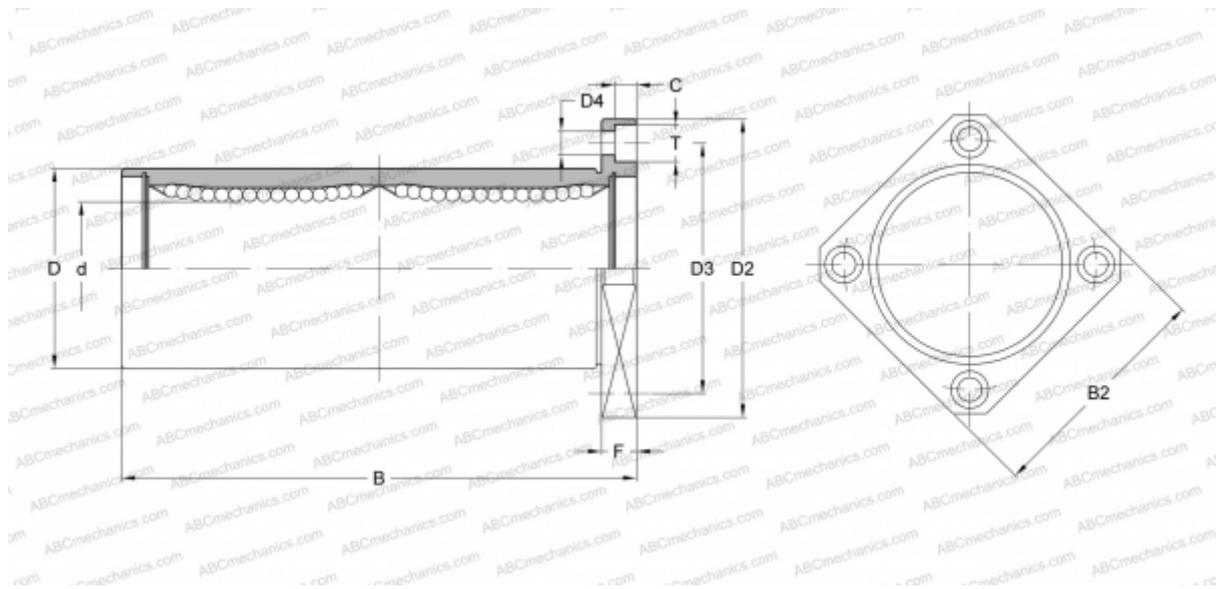

Technical specification

DIMENSIONS, MM

d	30,000
D	47,000
B	123,000
D2	76,000
D3	62,000
D4	6,600
B2	60,000
T	11,000
C	6,100
F	10

WEIGHT, KG 0,720

MANUFACTURER [NB](#)