

## KBSK 20W NB

Linear bushing

TYPE: Shaft guidance systems, Linear bushing, With flange, Square type, double length, Type KBK..W, European standard, Corrosion resistance, Stainless steel cage (NB)

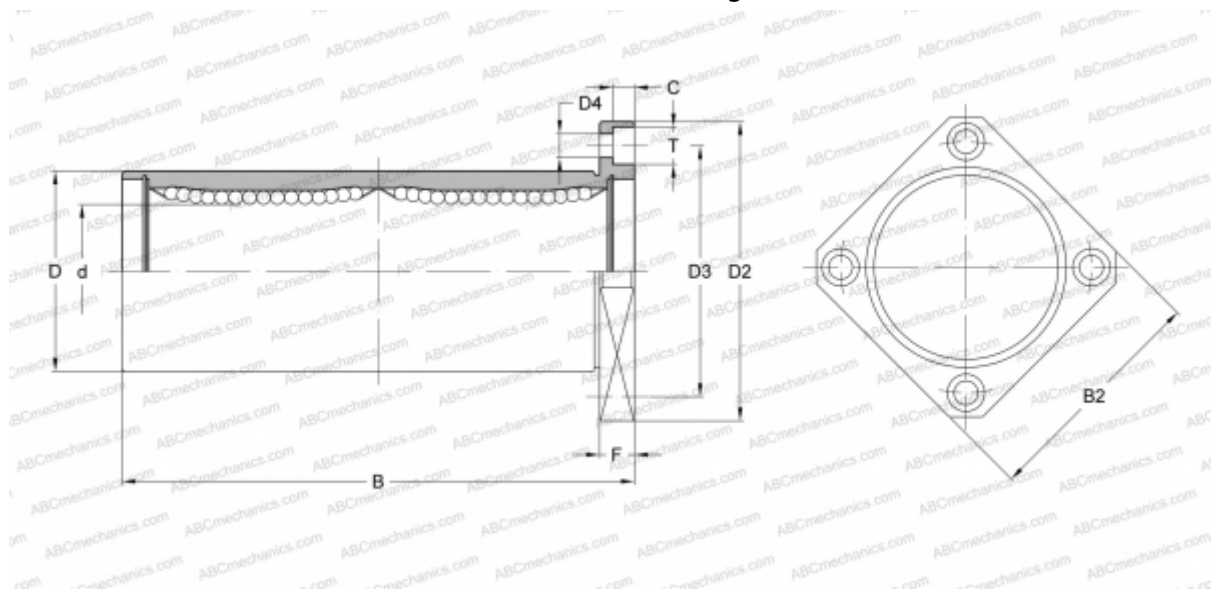

### Technical specification

#### DIMENSIONS, MM

d	20,000
D	32,000
B	80,000
D2	54,000
D3	43,000
D4	5,500
B2	42,000
T	9,000
C	5,100
F	8

**WEIGHT, KG** 0,225

**MANUFACTURER** [NB](#)