

## KBFC 16 NB

Linear bushing

TYPE: Shaft guidance systems, Linear bushing, Middle flange location, Circular type, Type KBFC, European standard, Steel cage (NB)

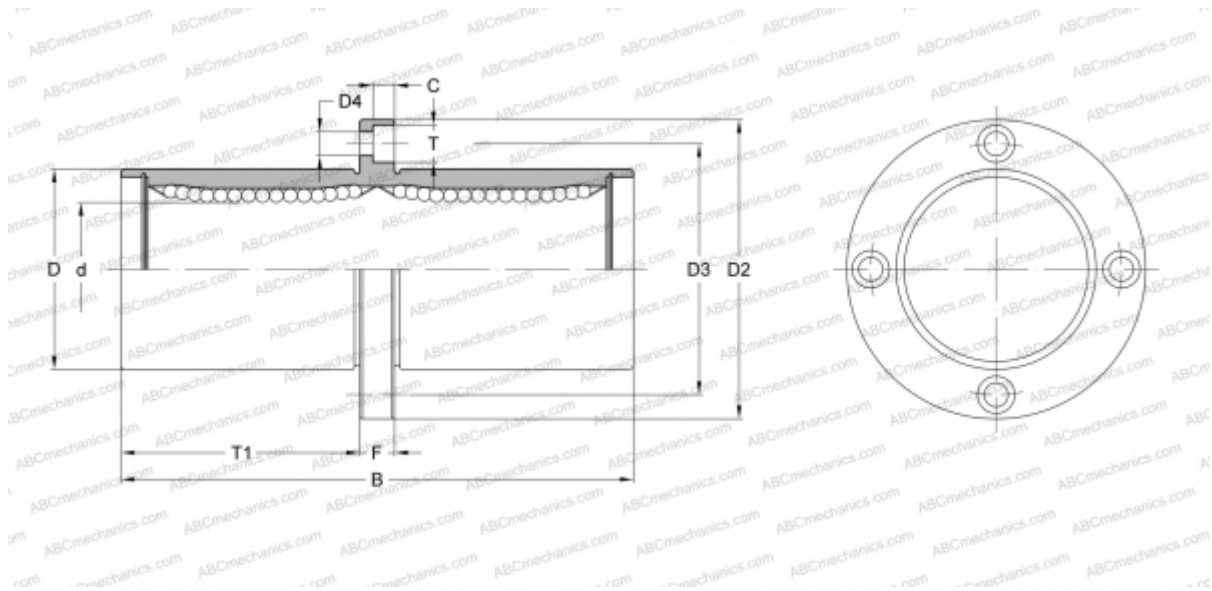

### Technical specification

#### DIMENSIONS, MM

d	16,000
D	26,000
B	68,000
D2	46,000
D3	36,000
D4	4,500
T	7,500
T1	31,000
C	4,100
F	6

**WEIGHT, KG** 0,160

**MANUFACTURER** [NB](#)