

KBSFC 12 NB

Linear bushing

TYPE: Shaft guidance systems, Linear bushing, Middle flange location, Circular type, Type KBFC, European standard, Corrosion resistance, Stainless steel cage (NB)

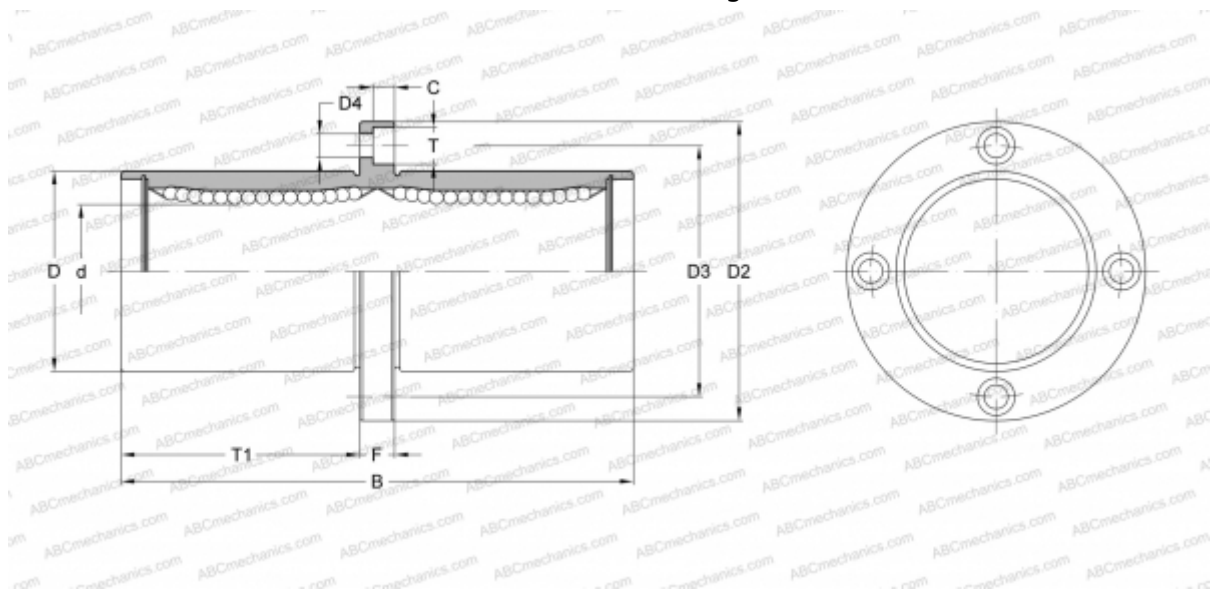

Technical specification

DIMENSIONS, MM

d	12,000
D	22,000
B	61,000
D2	42,000
D3	32,000
D4	4,500
T	7,500
T1	27,500
C	4,100
F	6

WEIGHT, KG 0,110

MANUFACTURER [NB](#)