

KBSFC 16G NB

Linear bushing

TYPE: Shaft guidance systems, Linear bushing, Middle flange location, Circular type, Type KBFC, European standard, Corrosion resistance, Plastic cage (NB)

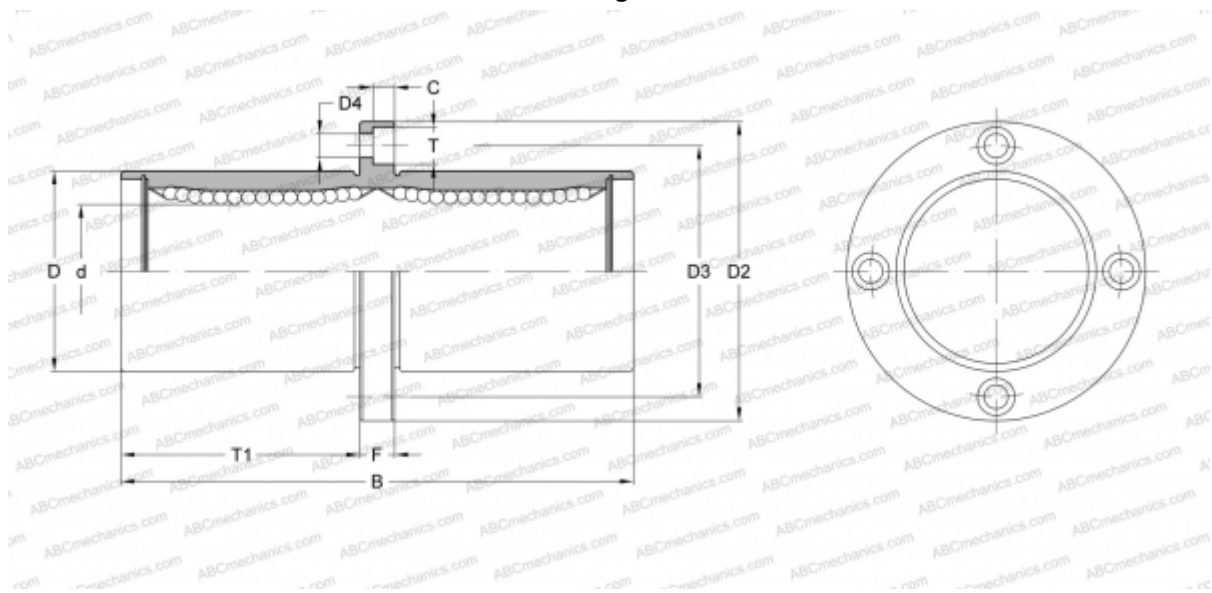

Technical specification

DIMENSIONS, MM

d	16,000
D	26,000
B	68,000
D2	46,000
D3	36,000
D4	4,500
T	7,500
T1	31,000
C	4,100
F	6

WEIGHT, KG 0,160

MANUFACTURER [NB](#)