

## KBSFC 25G NB

Linear bushing

TYPE: Shaft guidance systems, Linear bushing, Middle flange location, Circular type, Type KBFC, European standard, Corrosion resistance, Plastic cage (NB)

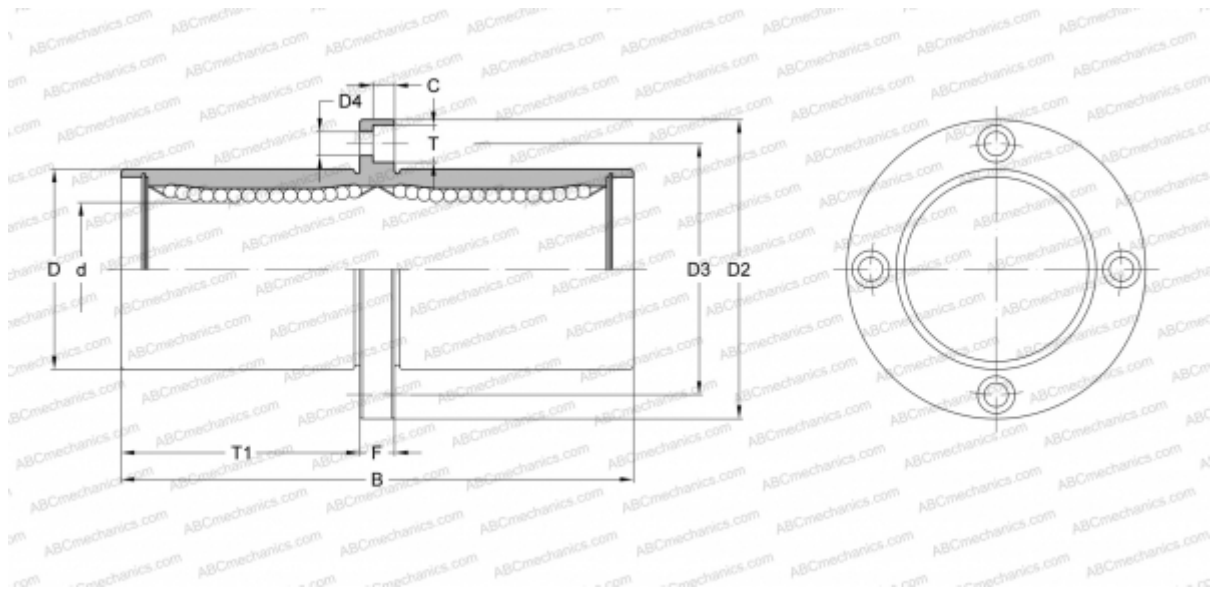

### Technical specification

#### DIMENSIONS, MM

d	25,000
D	40,000
B	112,000
D2	62,000
D3	51,000
D4	5,500
T	9,000
T1	52,000
C	5,100
F	8

**WEIGHT, KG** 0,540

**MANUFACTURER** [NB](#)