

KBSFC 40G NB

Linear bushing

TYPE: Shaft guidance systems, Linear bushing, Middle flange location, Circular type, Type KBFC, European standard, Corrosion resistance, Plastic cage (NB)

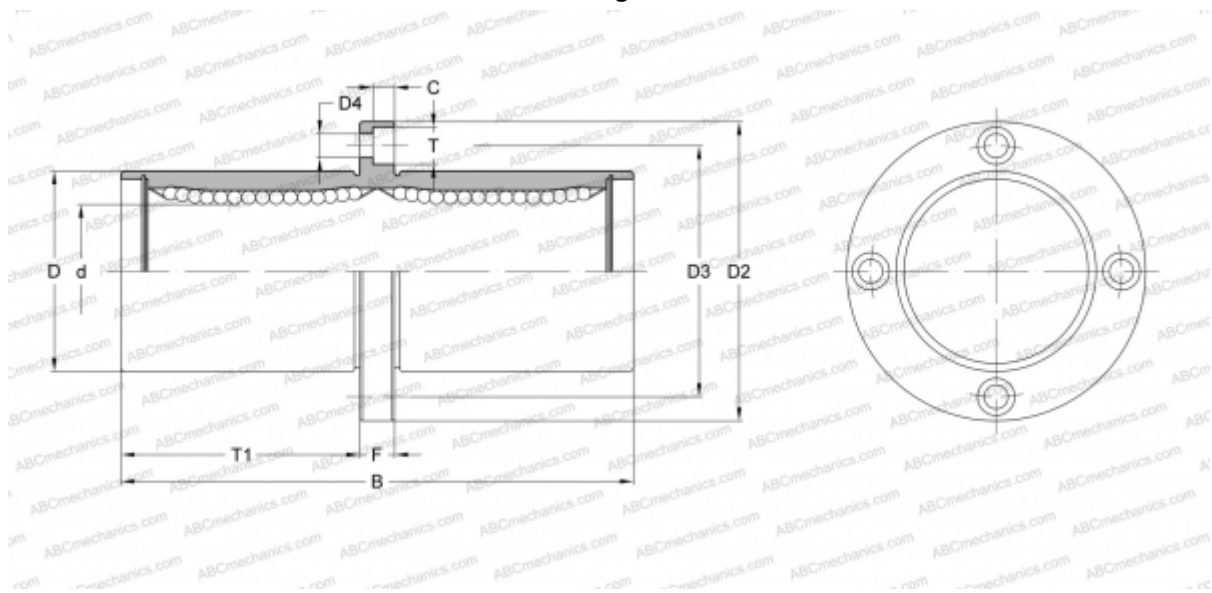

Technical specification

DIMENSIONS, MM

d	40,000
D	62,000
B	151,000
D2	98,000
D3	80,000
D4	9,000
T	14,000
T1	69,000
C	8,100
F	13

WEIGHT, KG 1,805

MANUFACTURER [NB](#)