

## KBSKC 60G NB

Linear bushing

TYPE: Shaft guidance systems, Linear bushing, Middle flange location, Square type, Type KBKC, European standard, Corrosion resistance, Plastic cage (NB)

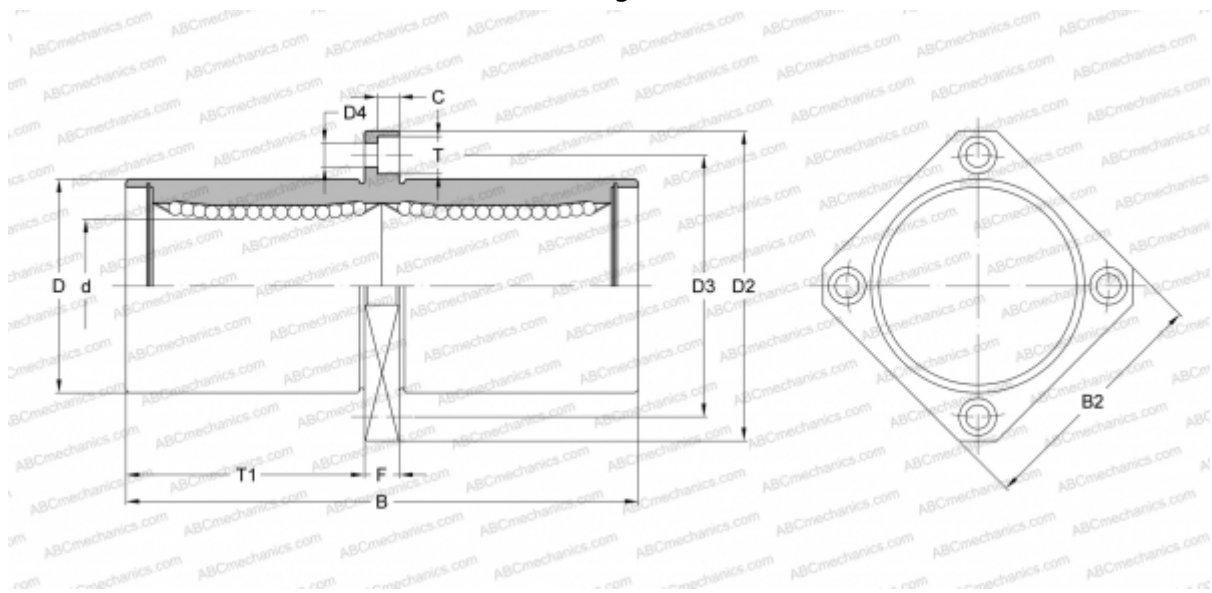

### Technical specification

#### DIMENSIONS, MM

d	60,000
D	90,000
B	209,000
D2	134,000
D3	112,000
D4	11,000
B2	106,000
T	17,000
T1	95,500
C	11,100
F	18

**WEIGHT, KG** 4,480

**MANUFACTURER** [NB](#)