

## SW 4 NB

Linear bushing

TYPE: Shaft guidance systems, Linear bushing, Standard, Close type, Type SW, American standard, Steel cage (NB)

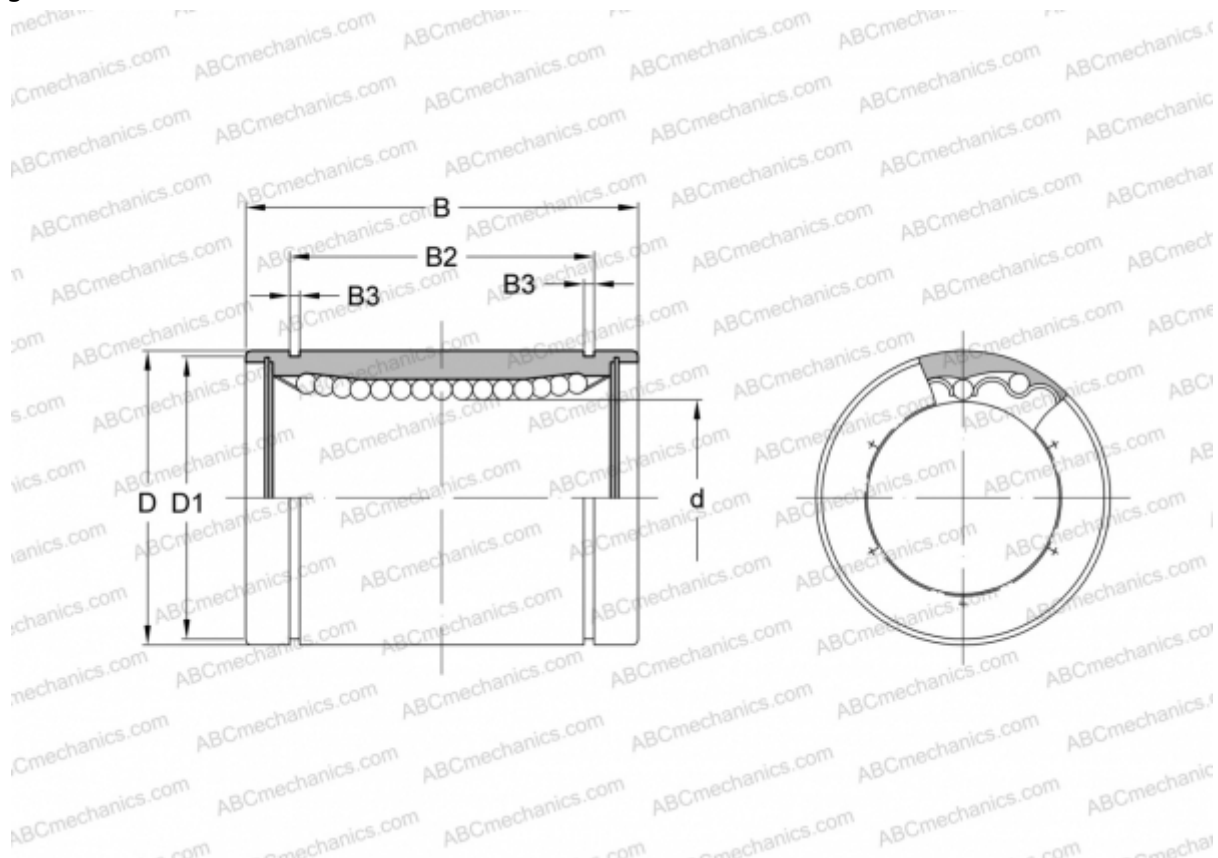

### Technical specification

#### DIMENSIONS, MM

d	6,350
D	12,700
B	19,050
D1	11,906
B2	12,980
B3	0,992

**WEIGHT, KG** 0,010

**MANUFACTURER** [NB](#)