

## SW 16 NB

Linear bushing

TYPE: Shaft guidance systems, Linear bushing, Standard, Close type, Type SW, American standard, Steel cage (NB)

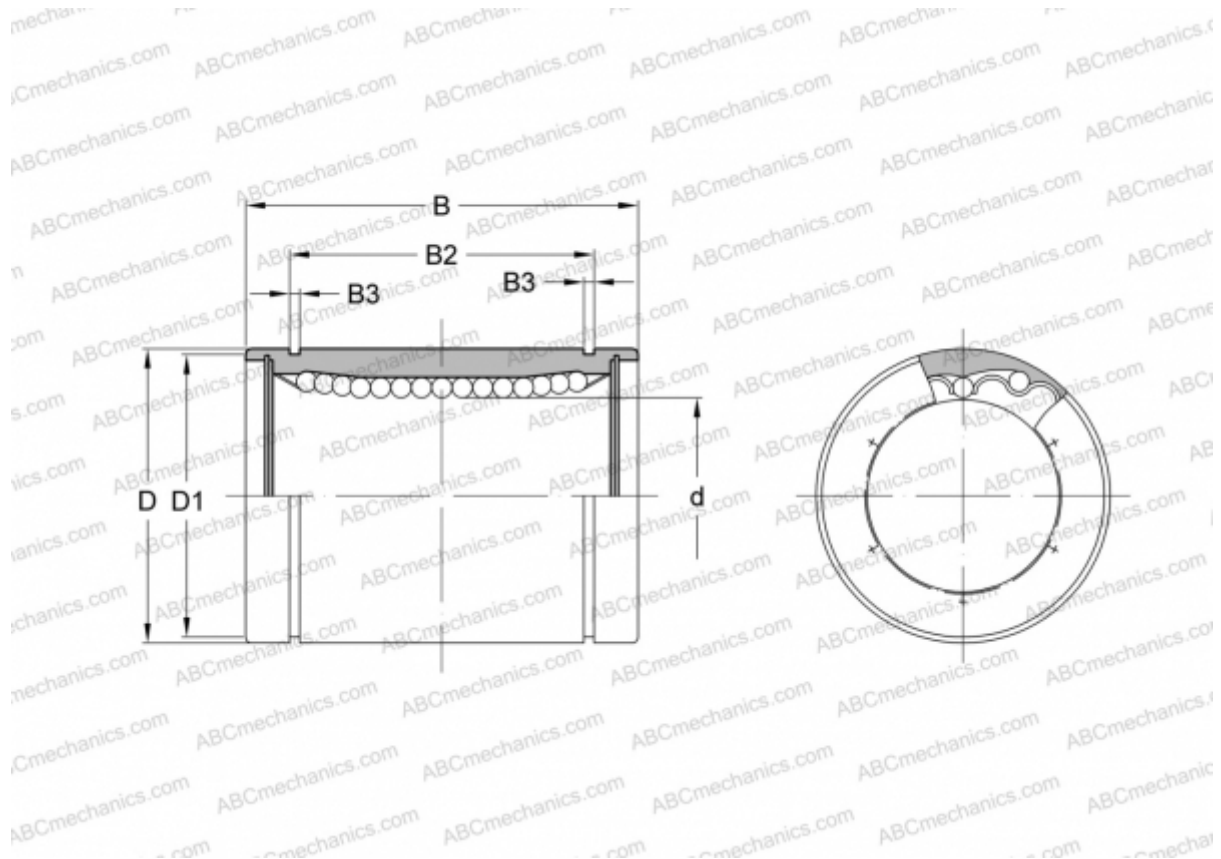

### Technical specification

#### DIMENSIONS, MM

d	25,400
D	39,688
B	57,150
D1	37,306
B2	44,570
B3	1,727

**WEIGHT, KG** 0,220

**MANUFACTURER** [NB](#)