

## SW 20 NB

Linear bushing

TYPE: Shaft guidance systems, Linear bushing, Standard, Close type, Type SW, American standard, Steel cage (NB)

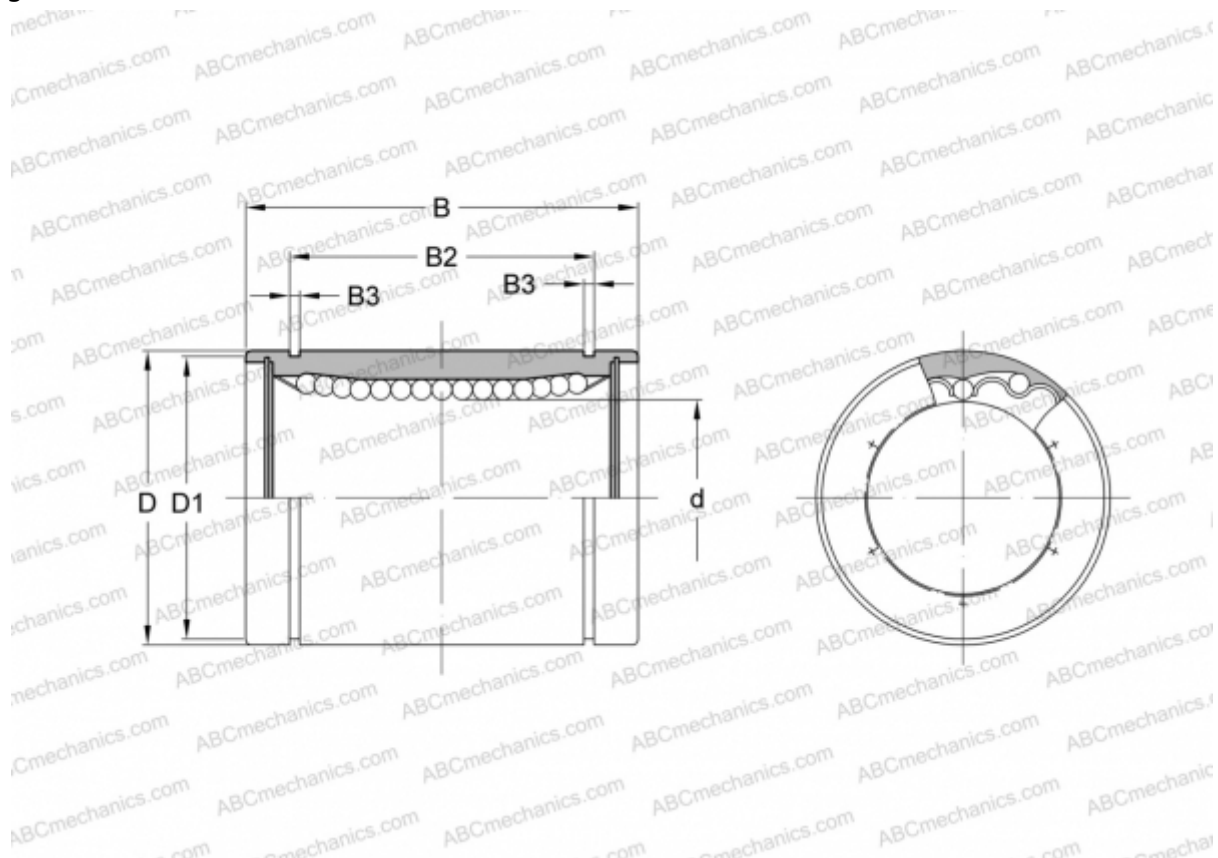

### Technical specification

#### DIMENSIONS, MM

d	31,750
D	50,800
B	66,675
D1	47,904
B2	50,920
B3	1,727

**WEIGHT, KG** 0,465

**MANUFACTURER** [NB](#)