

SW 32 NB

Linear bushing

TYPE: Shaft guidance systems, Linear bushing, Standard, Close type, Type SW, American standard, Steel cage (NB)

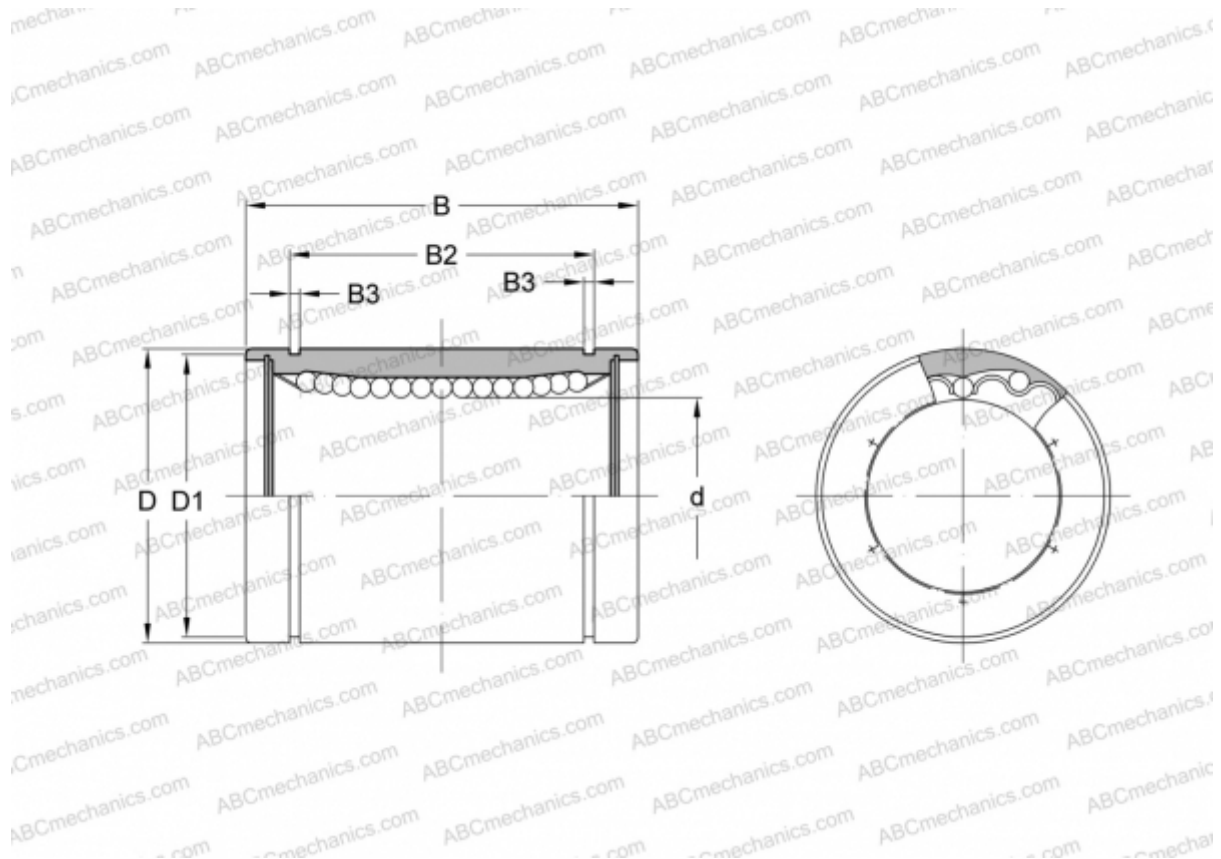

Technical specification

DIMENSIONS, MM

d	50,800
D	76,200
B	101,600
D1	72,085
B2	81,070
B3	2,616

WEIGHT, KG 1,310

MANUFACTURER [NB](#)