

SW 6G NB

Linear bushing

TYPE: Shaft guidance systems, Linear bushing, Standard, Close type, Type SW, American standard, Plastic cage (NB)

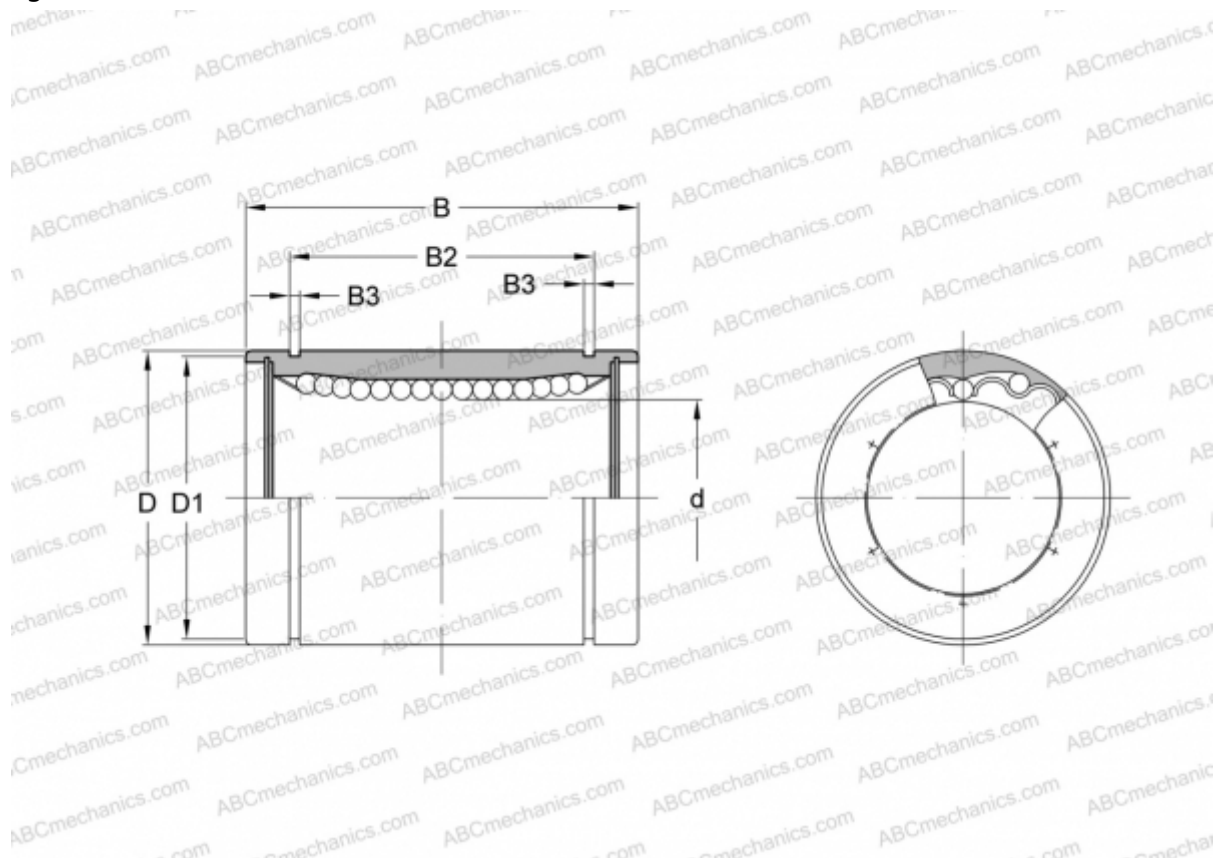

Technical specification

DIMENSIONS, MM

d	9,525
D	15,875
B	22,225
D1	14,935
B2	16,150
B3	0,992

WEIGHT, KG 0,015

MANUFACTURER [NB](#)