

SW 10G NB

Linear bushing

TYPE: Shaft guidance systems, Linear bushing, Standard, Close type, Type SW, American standard, Plastic cage (NB)

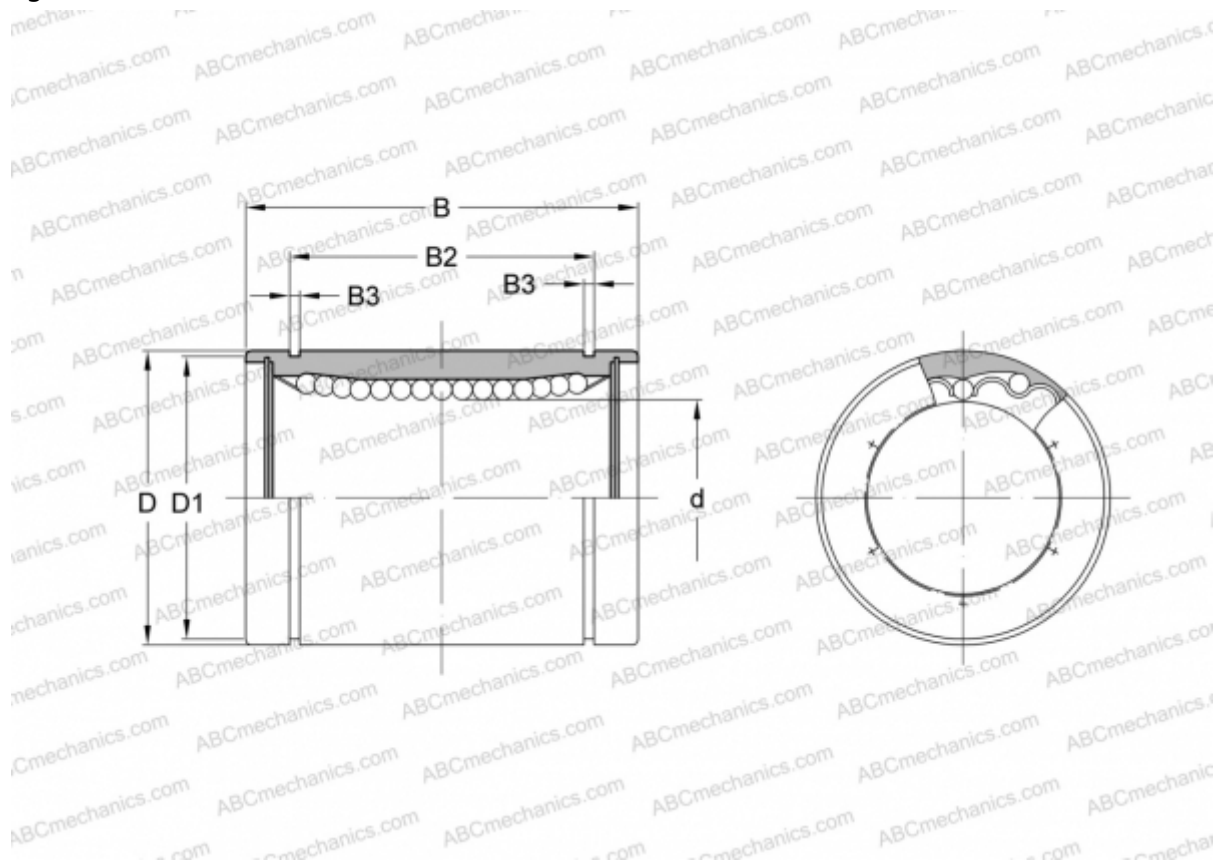

Technical specification

DIMENSIONS, MM

d	15,875
D	28,575
B	38,100
D1	26,899
B2	28,040
B3	1,422

WEIGHT, KG 0,085

MANUFACTURER [NB](#)