

SW 20G NB

Linear bushing

TYPE: Shaft guidance systems, Linear bushing, Standard, Close type, Type SW, American standard, Plastic cage (NB)

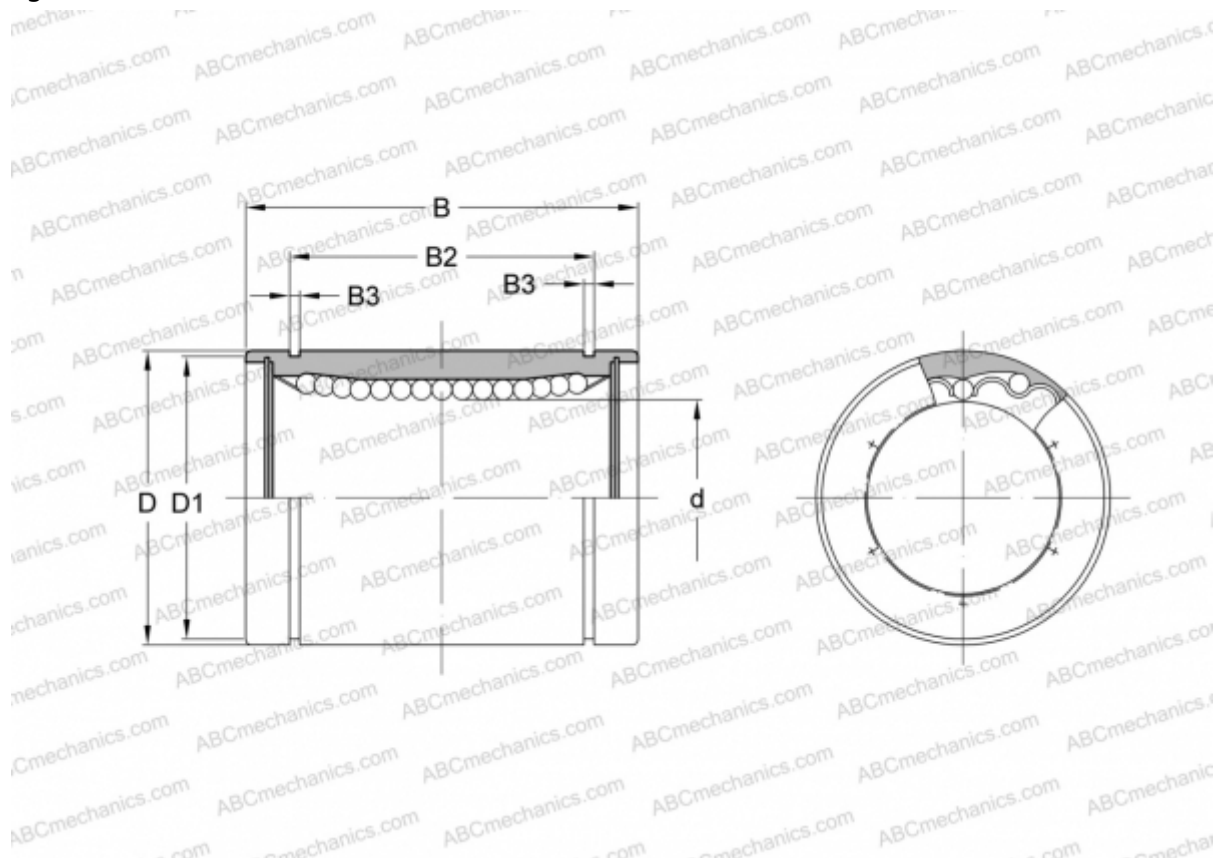

Technical specification

DIMENSIONS, MM

d	31,750
D	50,800
B	66,675
D1	47,904
B2	50,920
B3	1,727

WEIGHT, KG 0,465

MANUFACTURER [NB](#)