

SWS 4 NB

Linear bushing

TYPE: Shaft guidance systems, Linear bushing, Standard, Close type, Type SW, American standard, Corrosion resistance, Stainless steel cage (NB)

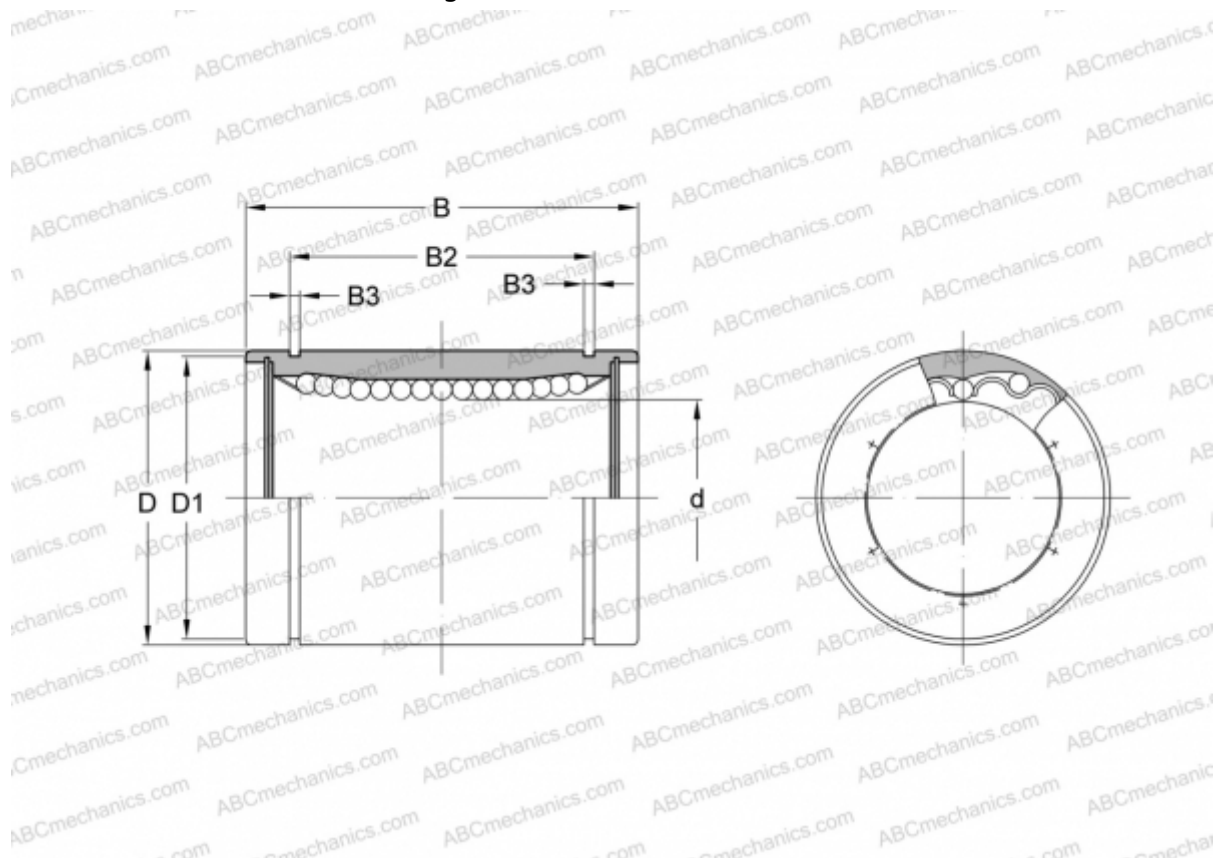

Technical specification

DIMENSIONS, MM

d	6,350
D	12,700
B	19,050
D1	11,906
B2	12,980
B3	0,992

WEIGHT, KG 0,010

MANUFACTURER [NB](#)