

## SWS 2G NB

Linear bushing

TYPE: Shaft guidance systems, Linear bushing, Standard, Close type, Type SW, American standard, Corrosion resistance, Plastic cage (NB)

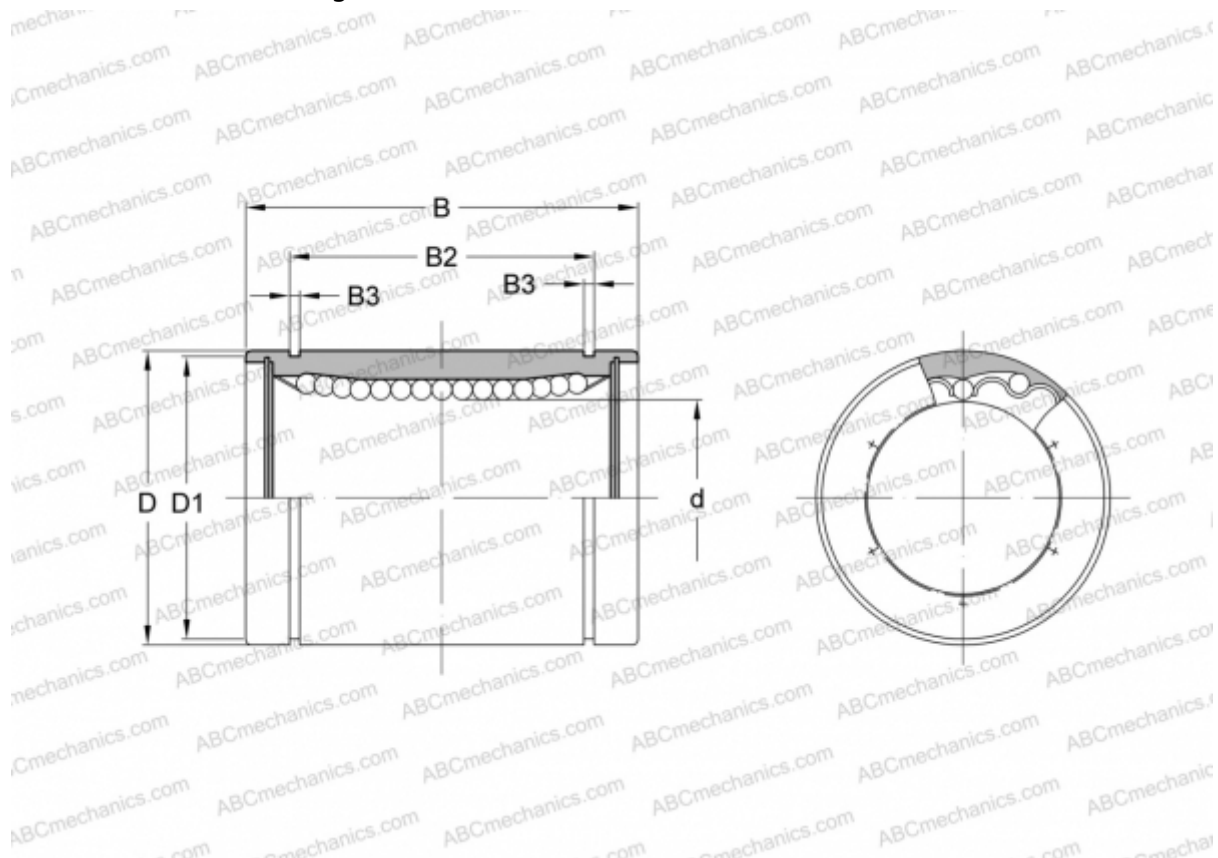

### Technical specification

#### DIMENSIONS, MM

d	3,175
D	7,938
B	12,700
D1	7,370
B2	9,350
B3	0,710

**WEIGHT, KG** 0,003

**MANUFACTURER** [NB](#)