

SWS 8G NB

Linear bushing

TYPE: Shaft guidance systems, Linear bushing, Standard, Close type, Type SW, American standard, Corrosion resistance, Plastic cage (NB)

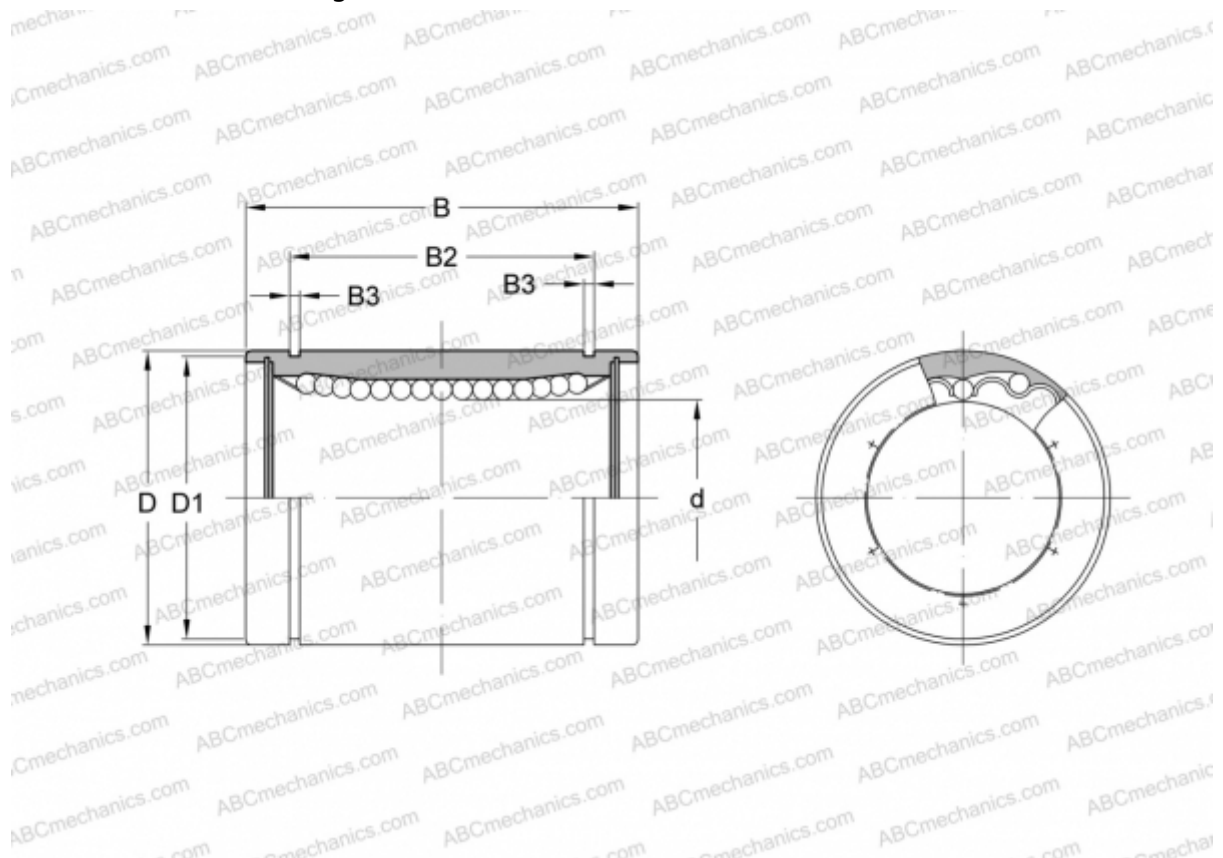

Technical specification

DIMENSIONS, MM

d	12,700
D	22,225
B	31,750
D1	20,853
B2	24,460
B3	1,168

WEIGHT, KG 0,042

MANUFACTURER [NB](#)