

SW 10-AJ NB

Linear bushing

TYPE: Shaft guidance systems, Linear bushing, Standard, Adjustable type, Type SW..AJ, American standard, Steel cage (NB)

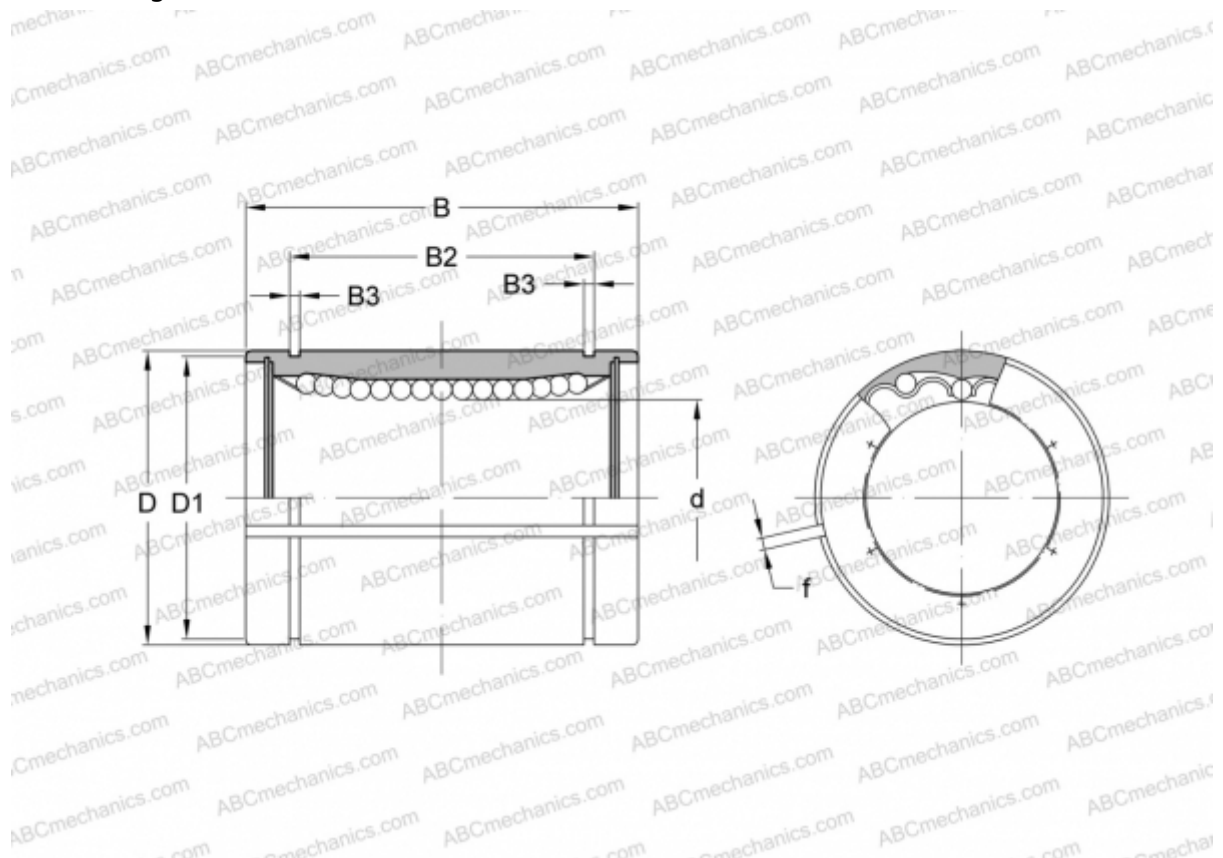

Technical specification

DIMENSIONS, MM

d	15,875
D	28,575
B	38,100
D1	26,899
B2	28,040
B3	1,422
f	1,500

WEIGHT, KG 0,083

MANUFACTURER [NB](#)