

## SW 12-AJ NB

Linear bushing

TYPE: Shaft guidance systems, Linear bushing, Standard, Adjustable type, Type SW..AJ, American standard, Steel cage (NB)

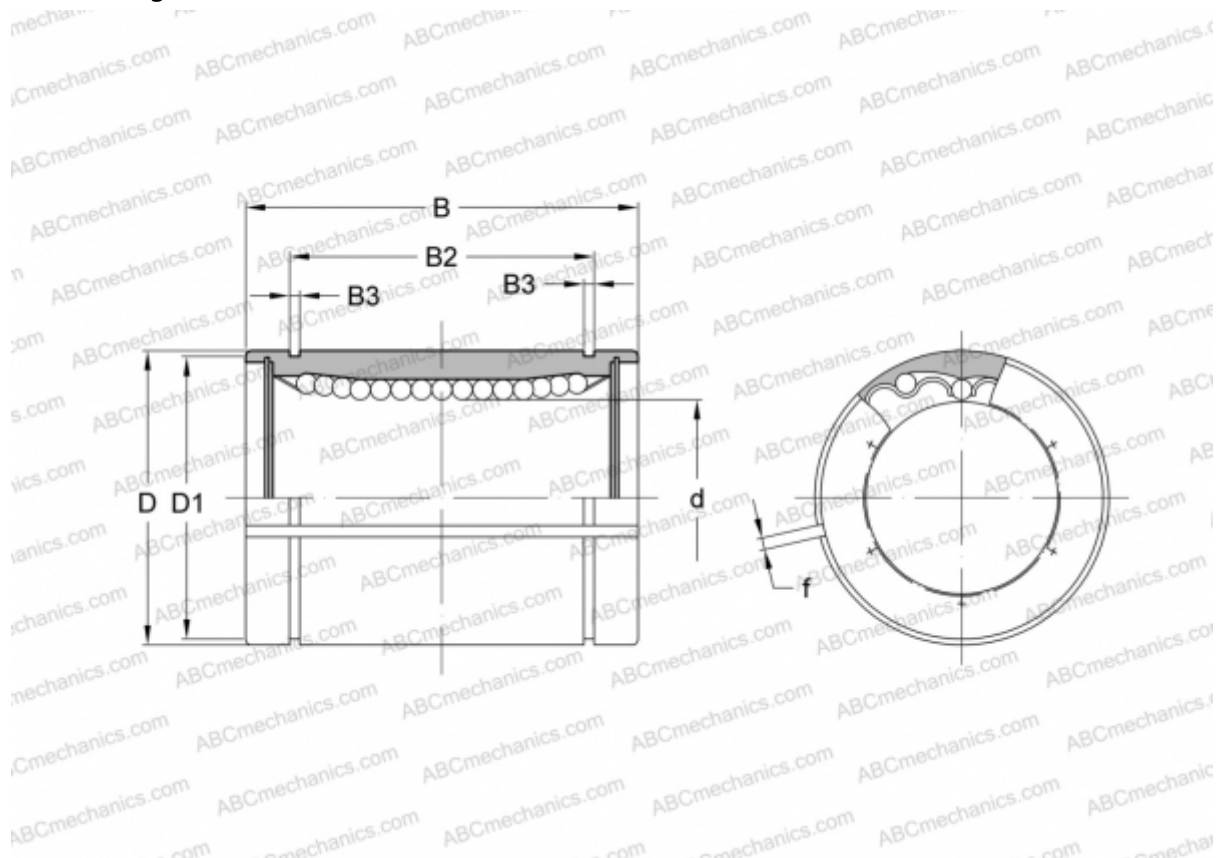

### Technical specification

#### DIMENSIONS, MM

d	19,050
D	31,750
B	41,275
D1	29,870
B2	29,610
B3	1,422
f	1,500

**WEIGHT, KG** 0,102

**MANUFACTURER** [NB](#)