

## SW 24-AJ NB

Linear bushing

TYPE: Shaft guidance systems, Linear bushing, Standard, Adjustable type, Type SW..AJ, American standard, Steel cage (NB)

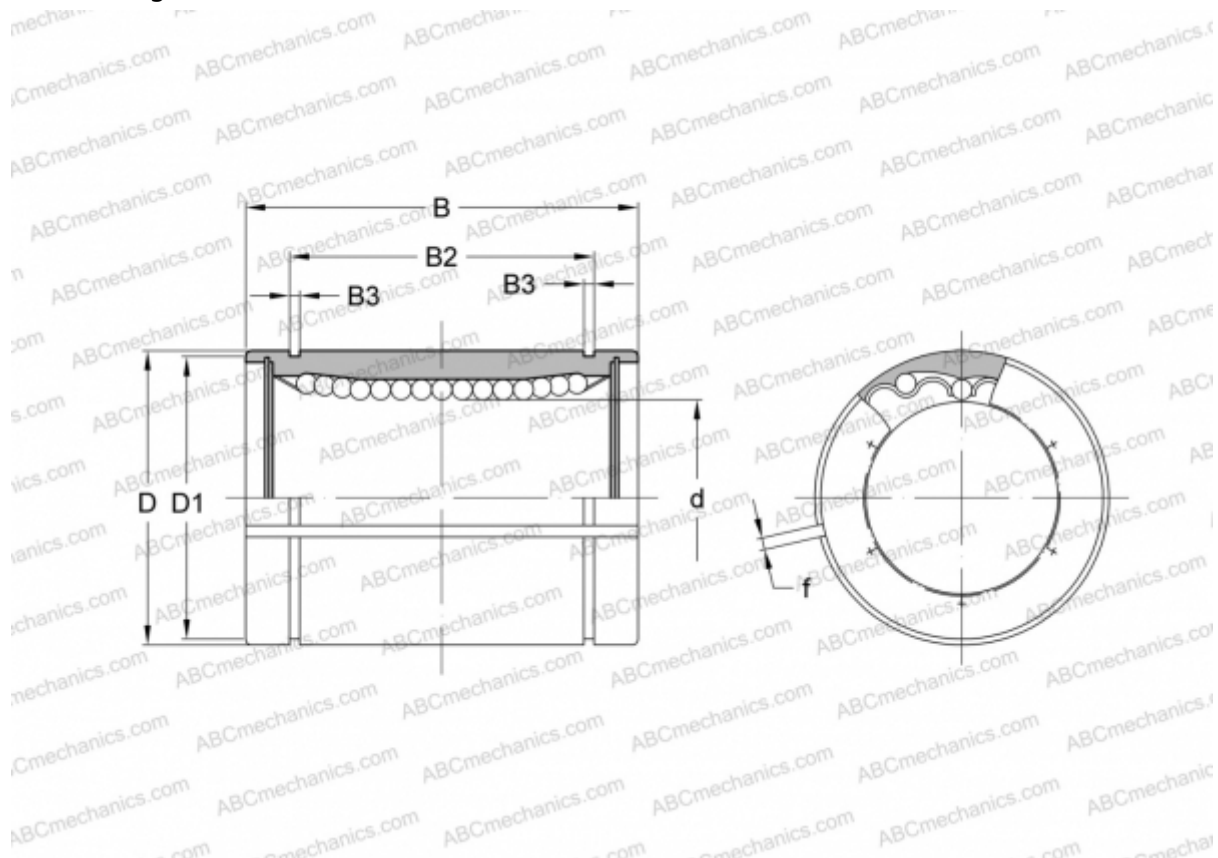

### Technical specification

#### DIMENSIONS, MM

d	38,100
D	60,325
B	76,200
D1	56,870
B2	61,260
B3	2,184
f	3,000

**WEIGHT, KG** 0,710

**MANUFACTURER** [NB](#)