

## SW 32-AJ NB

Linear bushing

TYPE: Shaft guidance systems, Linear bushing, Standard, Adjustable type, Type SW..AJ, American standard, Steel cage (NB)

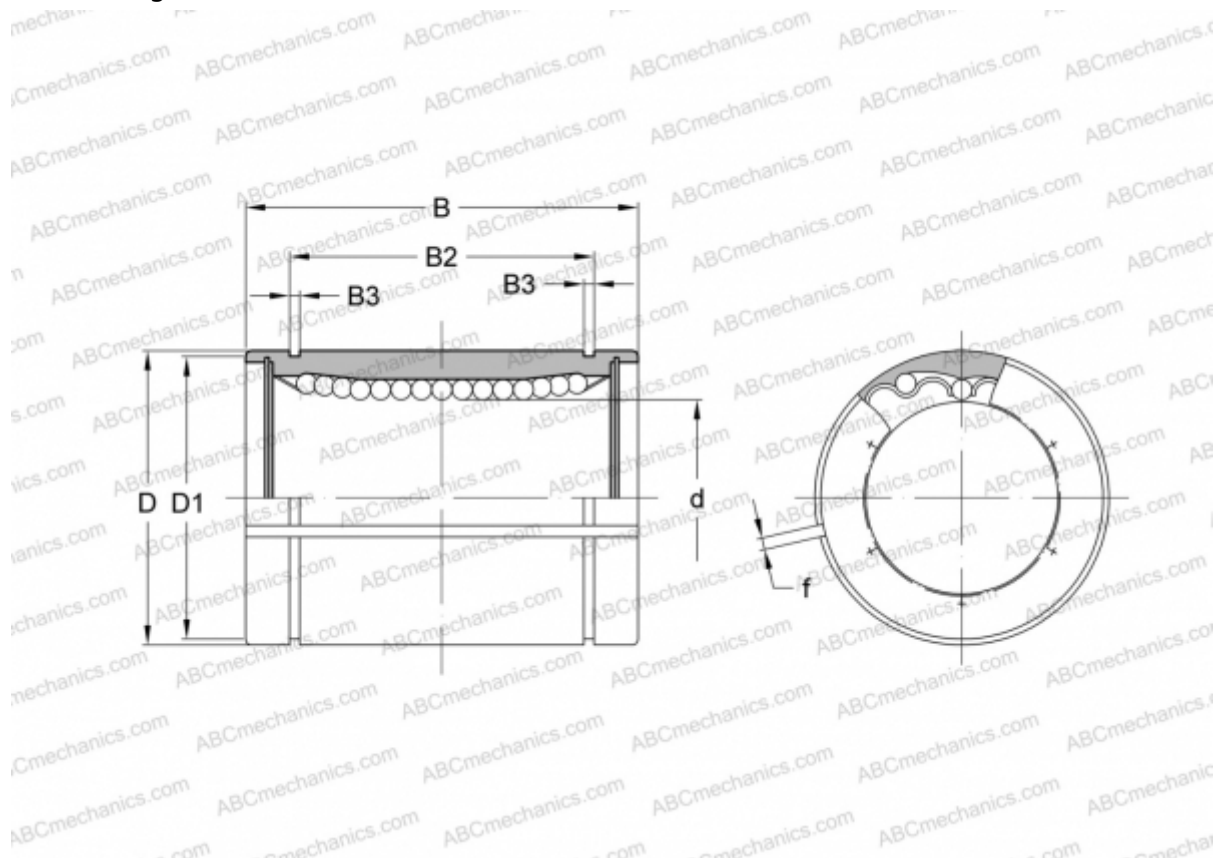

### Technical specification

#### DIMENSIONS, MM

d	50,800
D	76,200
B	101,600
D1	72,085
B2	81,070
B3	2,616
f	3,000

**WEIGHT, KG** 1,290

**MANUFACTURER** [NB](#)