

## SW 40-AJ NB

Linear bushing

TYPE: Shaft guidance systems, Linear bushing, Standard, Adjustable type, Type SW..AJ, American standard, Steel cage (NB)

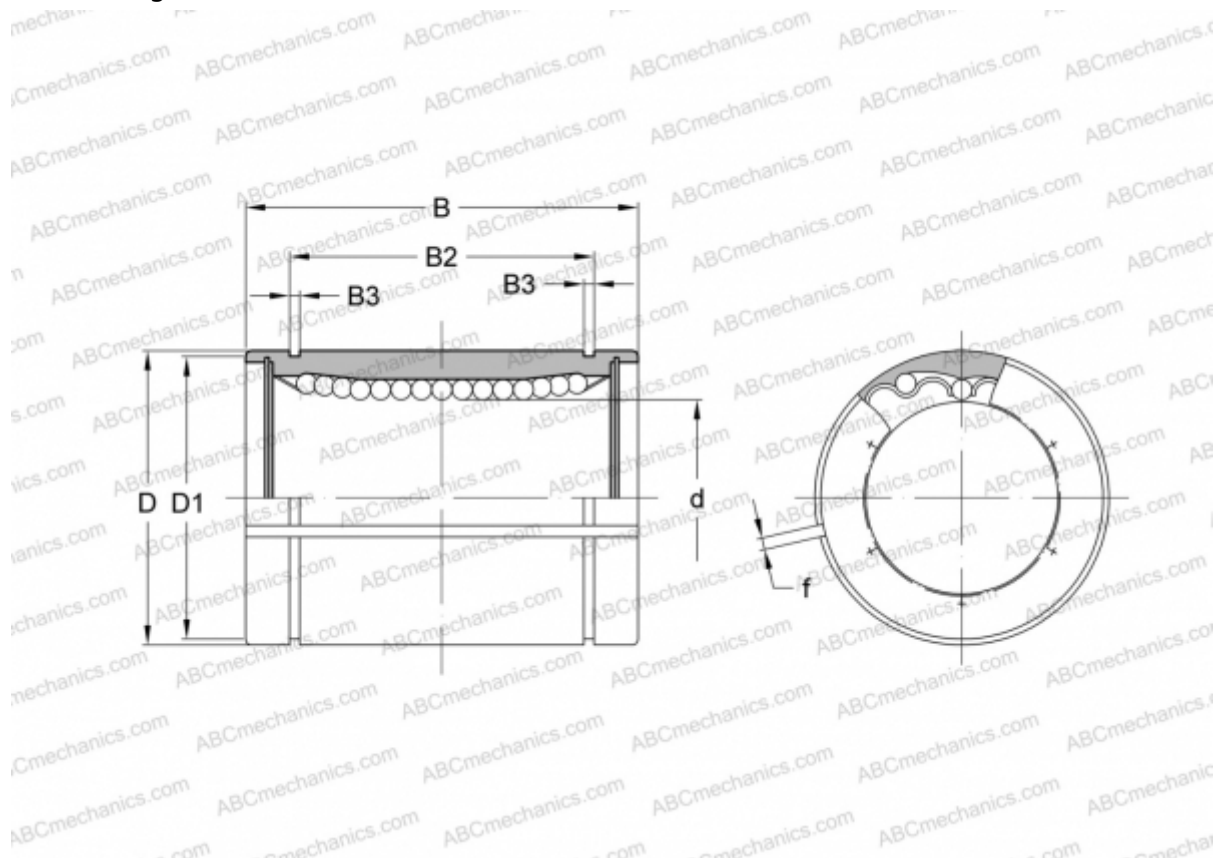

### Technical specification

#### DIMENSIONS, MM

d	63,500
D	95,250
B	127,000
D1	90,220
B2	100,990
B3	3,048
f	3,000

**WEIGHT, KG** 2,560

**MANUFACTURER** [NB](#)