

## SW 8G-AJ NB

Linear bushing

TYPE: Shaft guidance systems, Linear bushing, Standard, Adjustable type, Type SW..AJ, American standard, Plastic cage (NB)

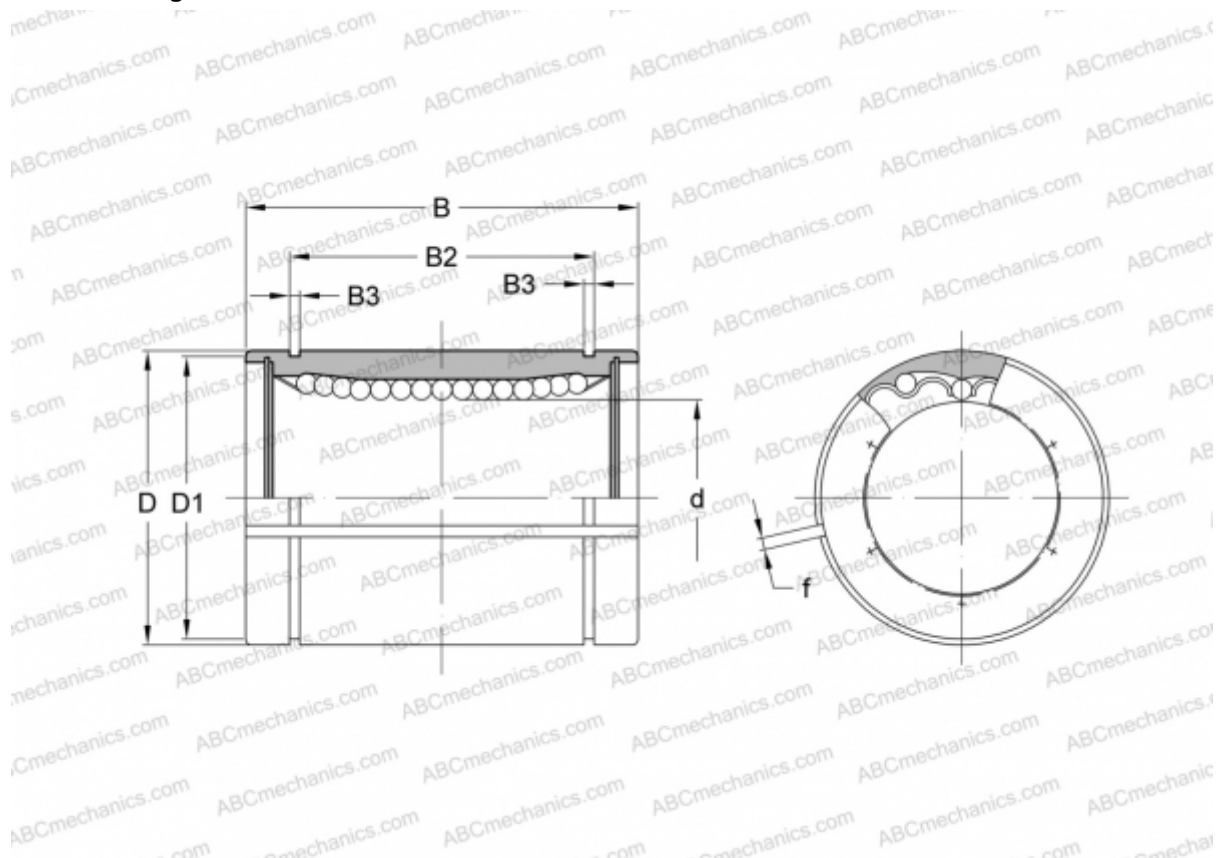

### Technical specification

#### DIMENSIONS, MM

d	12,700
D	22,225
B	31,750
D1	20,853
B2	24,460
B3	1,168
f	1,500

**WEIGHT, KG** 0,041

**MANUFACTURER** [NB](#)