

## SWS 4G-AJ NB

Linear bushing

TYPE: Shaft guidance systems, Linear bushing, Standard, Adjustable type, Type SW..AJ, American standard, Corrosion resistance, Plastic cage (NB)

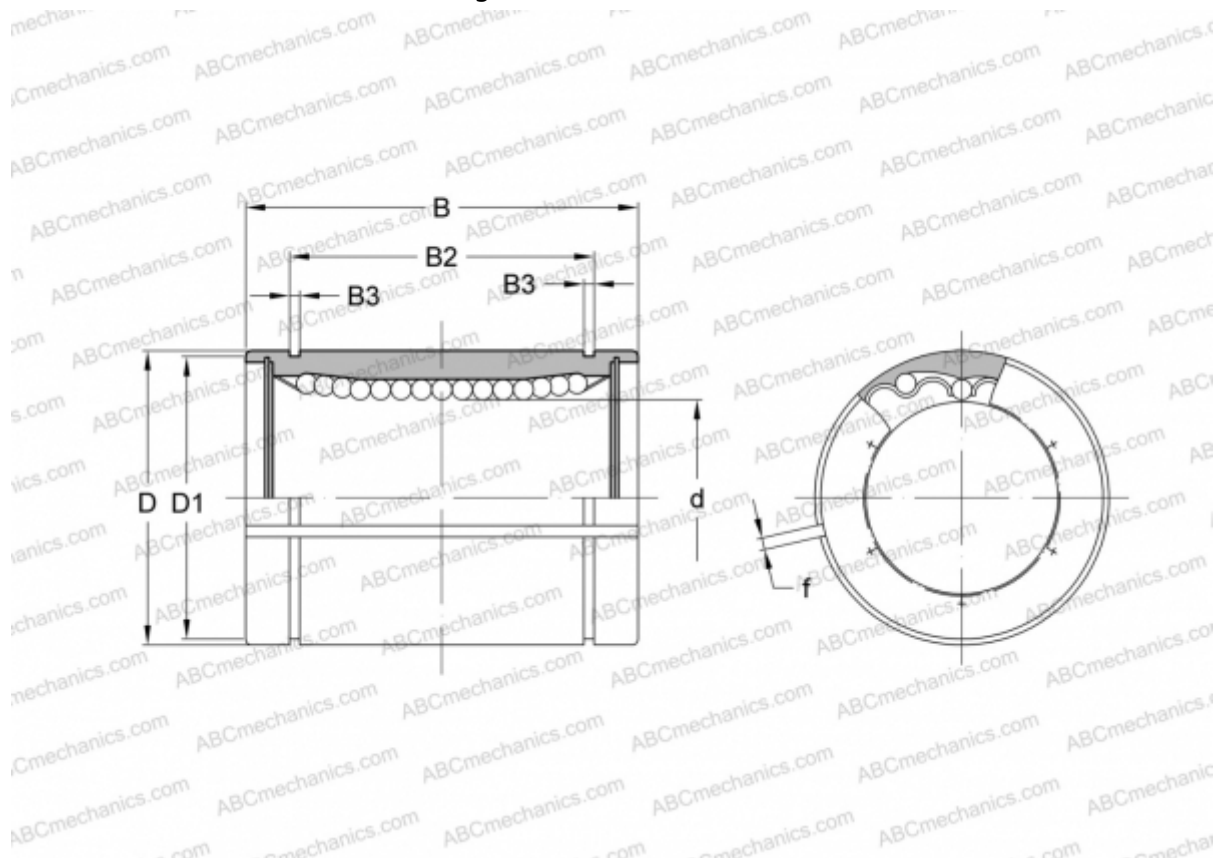

### Technical specification

#### DIMENSIONS, MM

d	6,350
D	12,700
B	19,050
D1	11,906
B2	12,980
B3	0,992
f	1,000

**WEIGHT, KG** 0,008

**MANUFACTURER** [NB](#)