

SWS 6G-AJ NB

Linear bushing

TYPE: Shaft guidance systems, Linear bushing, Standard, Adjustable type, Type SW..AJ, American standard, Corrosion resistance, Plastic cage (NB)

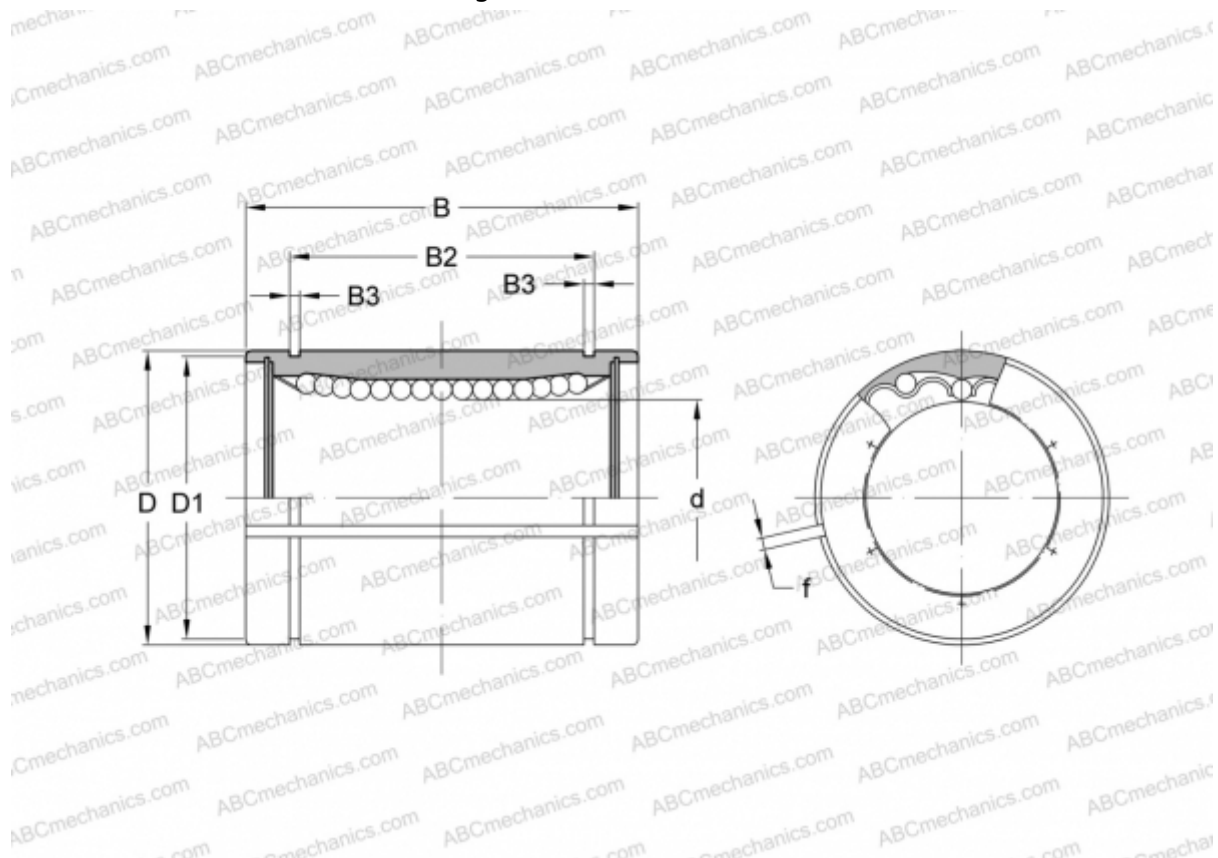

Technical specification

DIMENSIONS, MM

d	9,525
D	15,875
B	22,225
D1	14,935
B2	12,150
B3	0,992
f	1,000

WEIGHT, KG 0,014

MANUFACTURER [NB](#)