

SWS 32G-AJ NB

Linear bushing

TYPE: Shaft guidance systems, Linear bushing, Standard, Adjustable type, Type SW..AJ, American standard, Corrosion resistance, Plastic cage (NB)

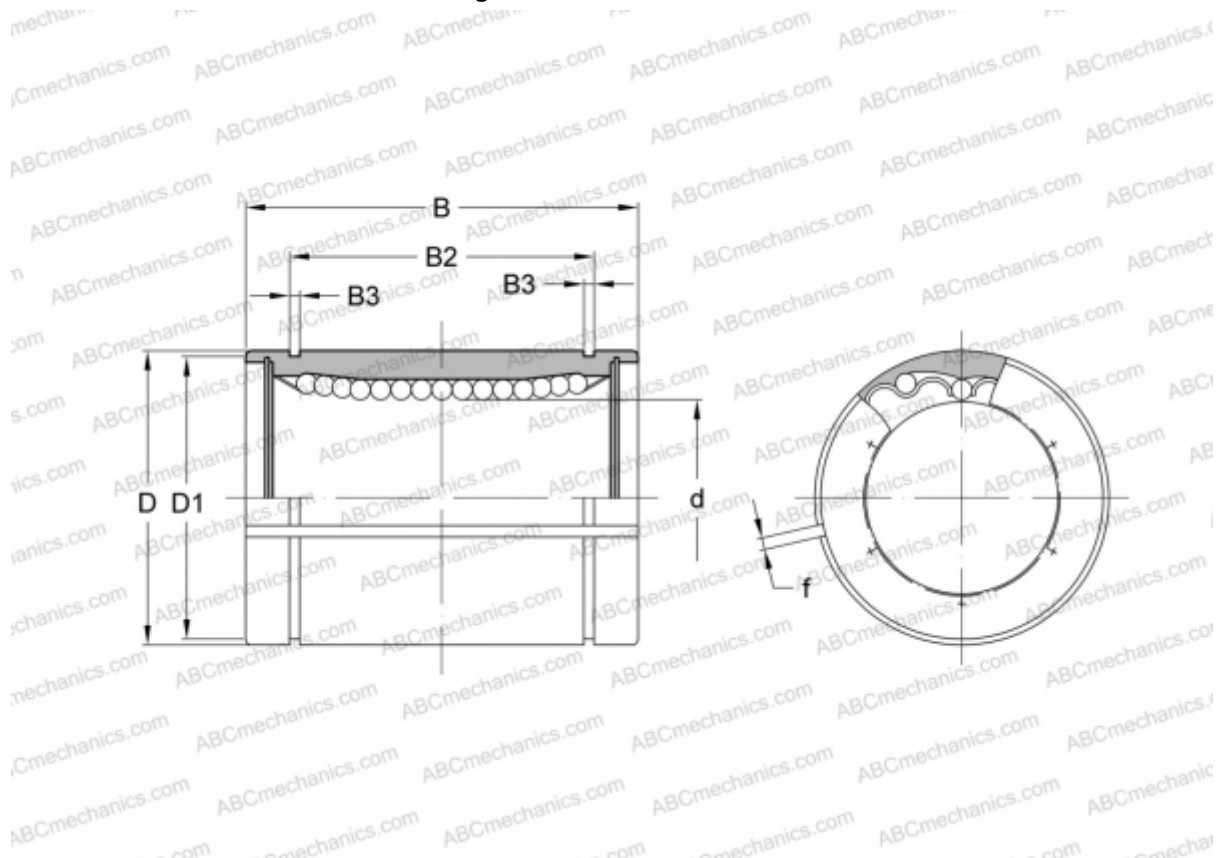

Technical specification

DIMENSIONS, MM

d	50,800
D	76,200
B	101,600
D1	72,085
B2	81,070
B3	2,616
f	3,000

WEIGHT, KG 1,290

MANUFACTURER [NB](#)