

SW 16-OP NB

Linear bushing

TYPE: Shaft guidance systems, Linear bushing, Standard, Open type for support rail, Type SW..OP, American standard, Steel cage (NB)

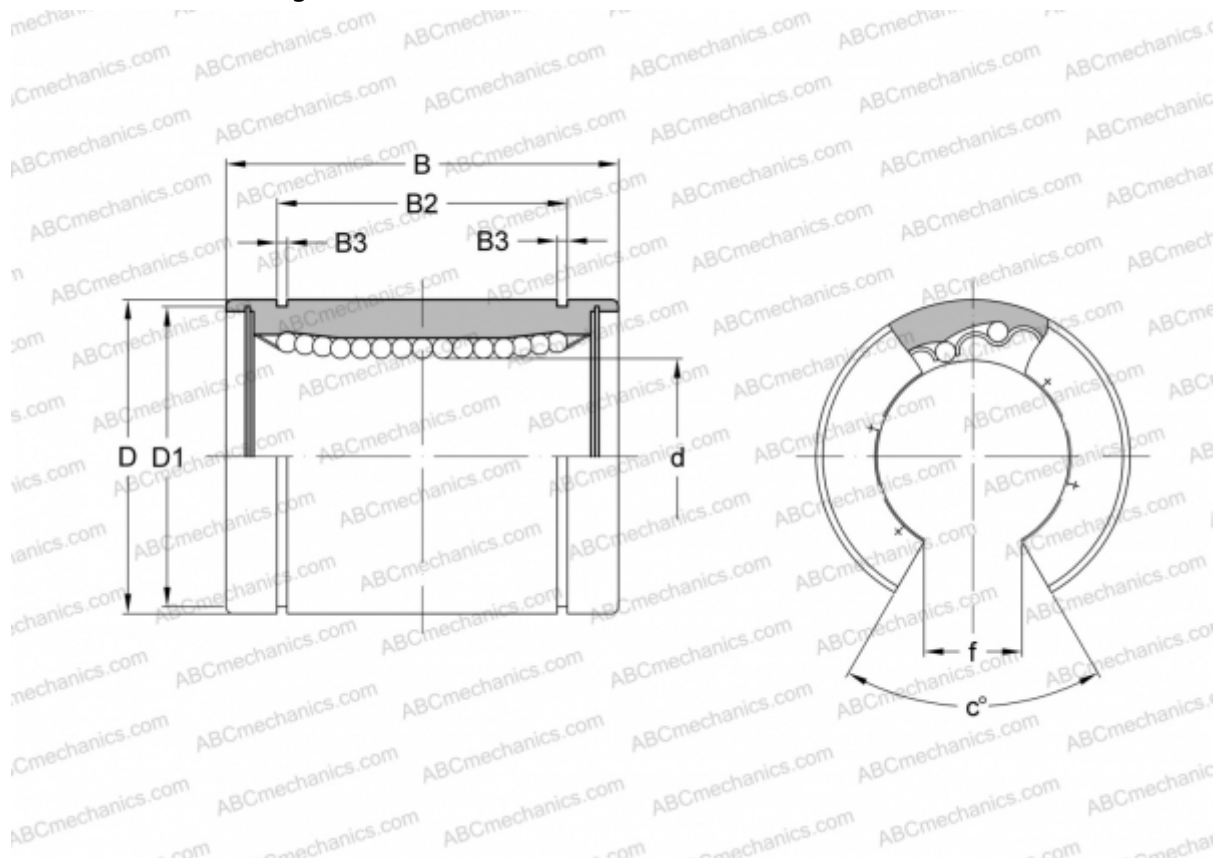

Technical specification

DIMENSIONS, MM

d	25,400
D	39,688
B	57,150
D1	37,306
B2	44,570
B3	1,727
f	14,288
c	50

WEIGHT, KG 0,190

MANUFACTURER [NB](#)