

SW 20-OP NB

Linear bushing

TYPE: Shaft guidance systems, Linear bushing, Standard, Open type for support rail, Type SW..OP, American standard, Steel cage (NB)

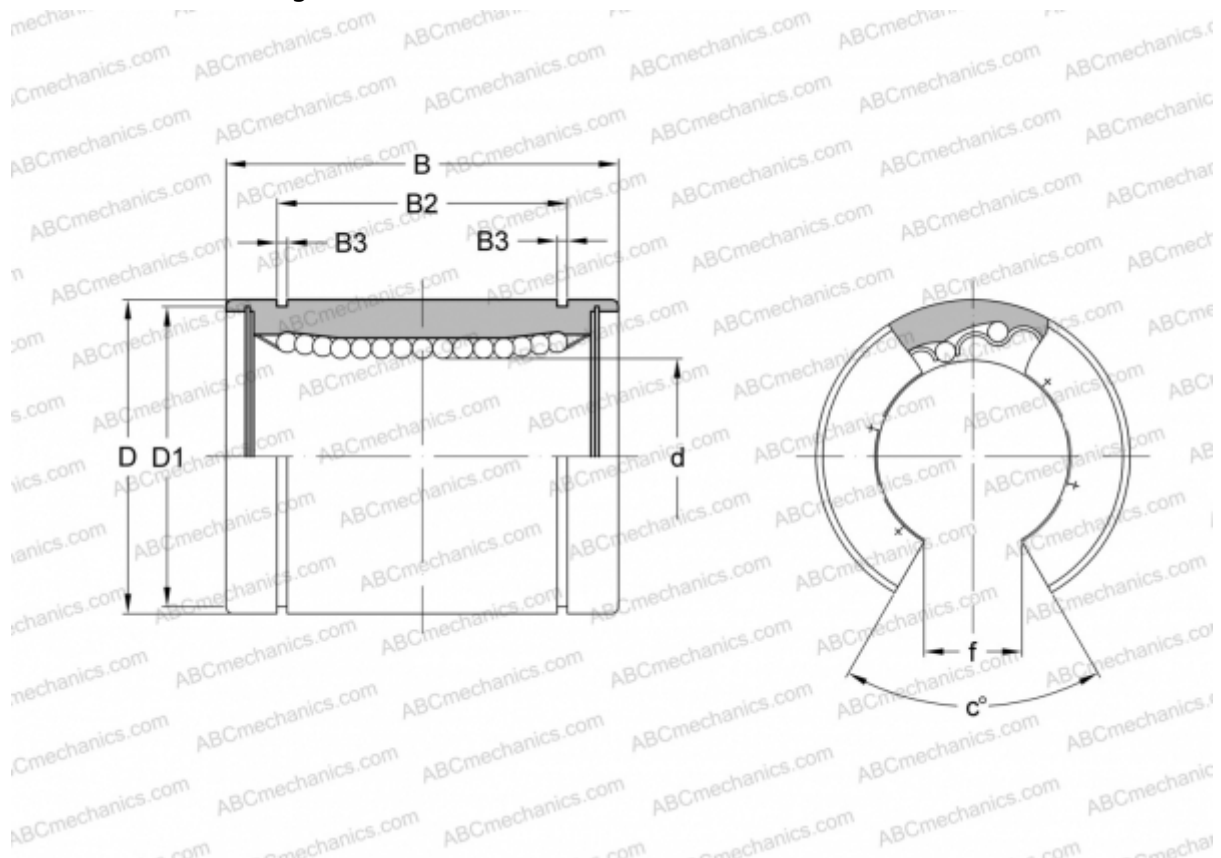

Technical specification

DIMENSIONS, MM

d	31,750
D	50,800
B	66,675
D1	47,904
B2	50,920
B3	1,727
f	15,875
c	50

WEIGHT, KG 0,390

MANUFACTURER [NB](#)