

SW 48-OP NB

Linear bushing

TYPE: Shaft guidance systems, Linear bushing, Standard, Open type for support rail, Type SW..OP, American standard, Steel cage (NB)

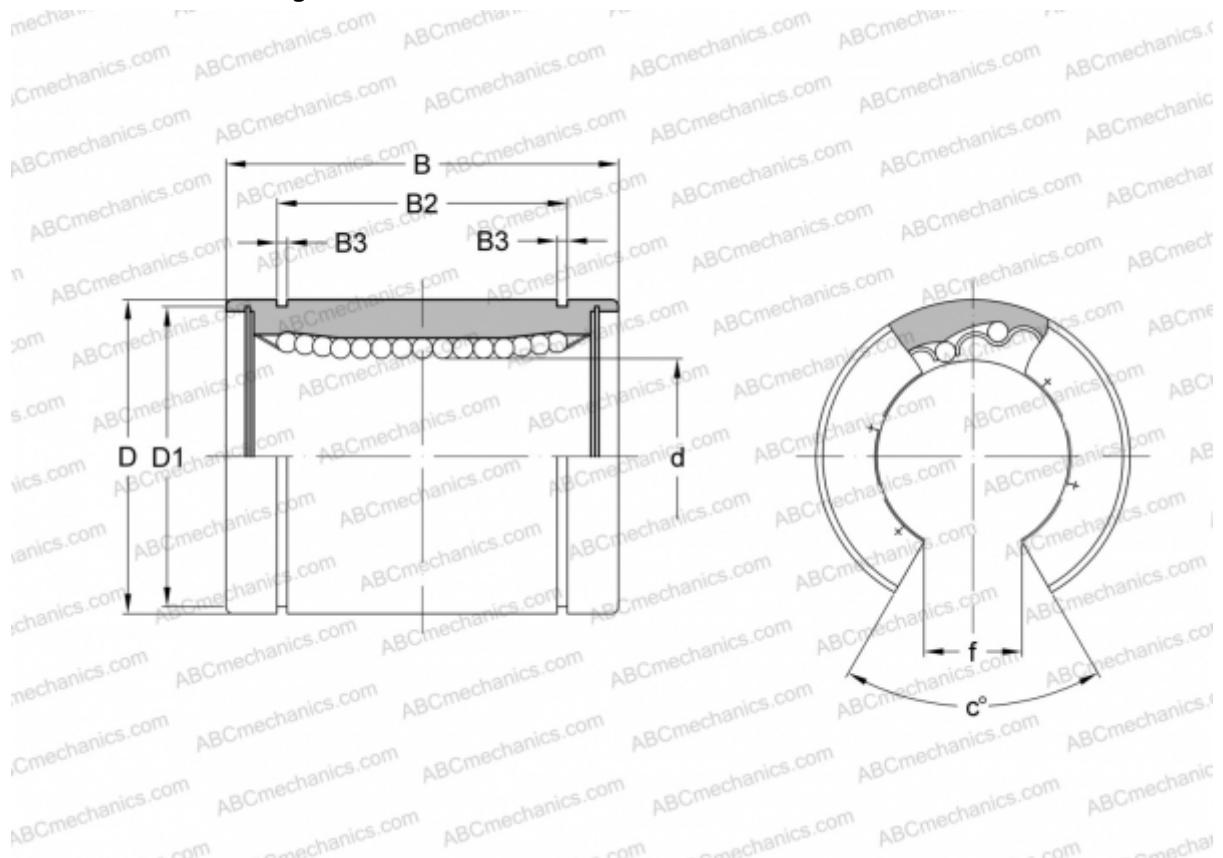

Technical specification

DIMENSIONS, MM

d	76,200
D	114,300
B	152,400
D1	109,474
B2	120,040
B3	3,048
f	38,100
c	50

WEIGHT, KG 3,750

MANUFACTURER [NB](#)